

NCB3000 Series

One Screen Combi Operation Manual

Second Edition (V 2.00)

FW: 160727a 이후 버전

Nowsystems Co. Ltd. Proprietary and Confidential

- This manual is for NCB3000 Series One Screen Combi machine.
- Any wrong installation and operation of the machine might result in lowering quality and accident so that please comply all the requirements written on this manual book..
- Please read this manual book carefully before using the machine.
- Please make sure to place this manual book around the machine.



REVISION HISTORY

| REVISION | VERSION | DATE | AUTHORS | DESCRIPTION |
|----------|---------|------------|---------|----------------------------|
| 1 | 1.00 | 2016-04-11 | | FIRST EDITION |
| 1 | 1.10 | 2016-07-06 | | 5.2.1 계량부 조립 수정 |
| 2 | 2.00 | 2016-07-27 | | 1SCREEN COMBI, EEC, M&S 추가 |
| | | | | |
| | | | | |
| | | | | |
| | | | | |
| | | | | |

Safety Sign

It is the precautions to prevent accident or risk by using a product safely and properly.

Signs to be used on the manual

| | |
|--|---|
|  Warning | In case any violation of instruction might result in serious injury or death |
|  Caution | In case any violation of instruction might result in minor injury or failure of the machine. |
|  Information | It explains information on how to operate the machine. |

Safety Reulation

For safe operation of the machine, please make sure the following before using it.

Warning

- Please make sure to plug the power cord to an outlet with water proof.
 - There is a risk of fire and injury caused by an electric short circuit.
 - Please do not disassemble he machine discretionally while the power is on
 - There is a risk of injury by electric shock and fire by electrical short circuit.
 - Please never put hands into any circulating part of the machine.
 - It may result in injury due to the fire.
 - Please do not damage the power cord, and when he outlet is loose, please stop using the machine.
 - If the electrical connection is unstable, there is a risk of heat and ignition.
-

Caution

- Please install the machine on the place not affected wind from a fan, an air conditioning and others.
 - Please install the machine by avoiding a heating element and direct sunlight..
 - Excessive temperature change inside the machine might result in a fatal failure of the machine.
 - Please install the machine on the consolidating and flat place without any vibration.
 - Otherwise, it could be the cause of the machine broken and malfunction.
 - Please be sure to connect the ground wire.
 - It may result in electric shock due to electric leakage
-

- Any person other than designated technicians and the personnel authorized by NOWSYSTEMS is not allowed to disassemble or repair / modify the machine.
(There is a risk of fatal injury and if after sales service is required, repairs will be made at cost even within he warranty period)

Contents

| | | |
|----------|--|-----------|
| 1.1 | SYSTEM CONFIGURATION | 7 |
| 1.2 | OPERATION DISPLAY | 8 |
| 1.2.1 | Main Screen | 9 |
| 1.2.2 | Judgement Display | 10 |
| 1.2.3 | Icon..... | 11 |
| 1.2.4 | Screen Operation | 12 |
| 2 | BASIC OPERATION | 16 |
| 2.1 | POWER ON / OFF | 16 |
| 2.2 | OPERATION / STOP | 16 |
| 2.3 | ZERO SETTING | 17 |
| 2.4 | USER SETTING CHANGE / PASSWORD CHANGE..... | 17 |
| 2.4.1 | user setting change..... | 18 |
| 2.4.2 | Password Change..... | 18 |
| 2.5 | MACHINE STATUS DIAGNOSIS & CHECKING | 19 |
| 3 | BASIC FUNCTION | 20 |
| 3.1 | DISPLAY DIAGRAM..... | 20 |
| 3.2 | SETTING PARAMETE | 20 |
| 3.2.1 | Product List..... | 20 |
| 3.2.2 | product information..... | 21 |
| 3.2.3 | DECISION TIMING ADJUSTING..... | 21 |
| 3.2.4 | REJECTION TIMING..... | 22 |
| 3.2.5 | METAL DETECTOR..... | 22 |
| 3.3 | PRODUCT REGISTERATION..... | 23 |
| 3.4 | PRODUCT CHANGE / DELETION / COPY | 25 |
| 3.4.1 | Product Change or Deletion | 25 |
| 3.4.2 | copy..... | 25 |
| 3.5 | DYNAMIC OFFSET | 26 |
| 3.6 | DECISION TIMING..... | 27 |
| 3.7 | REJECTION TIMING..... | 28 |
| 3.8 | METAL DETECTOR SETTING (OPTION)..... | 29 |
| 3.8.1 | AUTO SETUP | 30 |
| 3.9 | PRODUCT RECORD..... | 32 |
| 3.9.1 | STATISTICS | 32 |
| 3.9.2 | EVENT | 34 |
| 3.10 | WEIGHT ADJUSTMENT | 35 |

| | | |
|----------|---|-----------|
| 4 | ADDITIONAL FUNCTION | 36 |
| 4.1 | SCREEN LEVEL TREE | 36 |
| 4.2 | SETTING PARAMETERS | 37 |
| 4.2.1 | REJECTION MANAGEMENT | 37 |
| 4.2.2 | PREFERENCES | 39 |
| 4.2.3 | INSTALLATION/MAINTENANCE | 41 |
| 4.2.4 | TIMING DIAGRAM FOR PORT SETTING | 44 |
| 4.3 | TOUCH CALIBRATION | 45 |
| 4.4 | BACK UP AND RESTORATION OF DATA | 46 |
| 4.5 | FIRMWARE UPDATE | 47 |
| 4.6 | SCALE SETTING | 48 |
| 5 | INSTALLATION | 49 |
| 5.1 | INSTALLATION PLACE SELELCT AND TRANSPORTAITON | 49 |
| 5.1.1 | INSTALLATION PLACE | 49 |
| 5.1.2 | TRANSPORTATION | 49 |
| 5.2 | INSTALLATION | 50 |
| 5.2.1 | ASSEMBLE WEIGHING CONVEYOR | 50 |
| 5.2.2 | FIXATION OF ADJUSTING LEGS | 53 |
| 5.2.3 | CONNETION TO EXTERNAL DEVICES | 54 |
| 5.2.4 | POWER – GROUNDING | 54 |
| 5.3 | COMMISSIONING | 55 |
| 5.3.1 | BEFORE STARTING COMMISSIONING | 55 |
| 5.3.2 | checking operation | 55 |
| 6 | MAINTENANCE | 56 |
| 6.1 | DAILY CHECK | 56 |
| 6.1.1 | DAILY CHECK POINTS | 56 |
| 6.1.2 | WEEKLY/MONTHLLY CHECK POINTS | 56 |
| 6.1.3 | CLEANING UP | 56 |
| 6.2 | SPARE PART ATTACHEMENT / DETACHMENT | 58 |
| 6.2.1 | DETACHMENT OF THE CONVEYOR UNIT | 58 |
| 6.2.2 | REPLACING CONVEYOR BELT / ROLLER | 59 |
| 6.2.3 | BELT LEANING (TENSION) ADJUSTMENT | 61 |
| 6.3 | TROUBLE SHOOTING | 62 |
| 6.3.1 | CAUSE & SOLUTION | 62 |

1. NAMES AND FUNCTIONS FOR EACH PART

1.1 SYSTEM CONFIGURATION

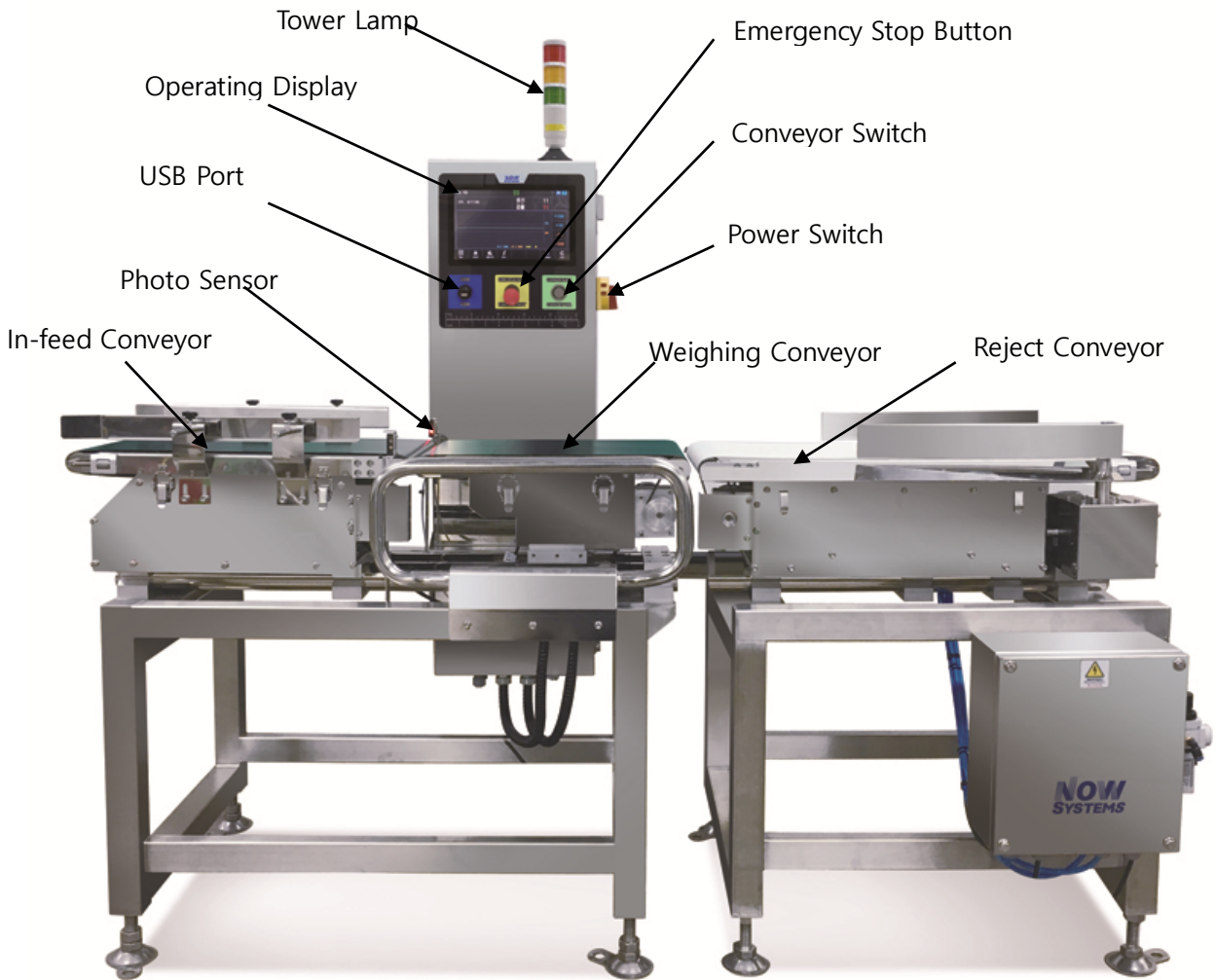

Note: A reject conveyor is optional.

Caution

Do not put hands on moving parts during operation of the machine.

1.2 OPERATION DISPLAY

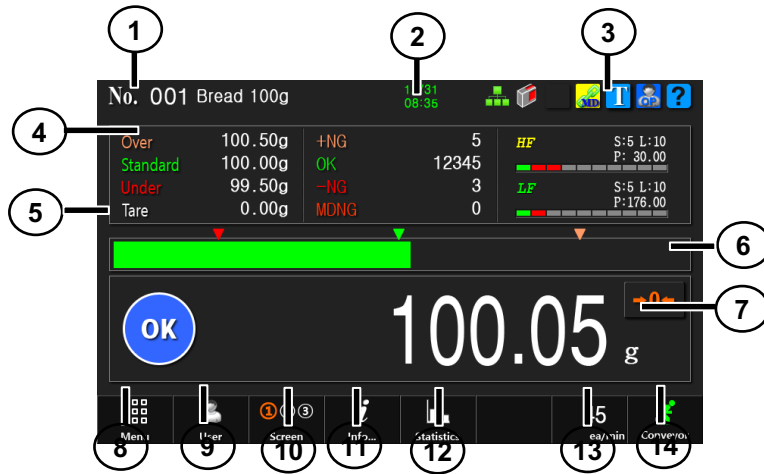

Caution

Do not touch the screen with a sharp device or nail. Otherwise, water proof function could be damaged.

- ① [Product Number/Name]
It shows the number and name of the production in production.
- ② [Current Date/Time]
It shows current time and date.
- ③ [Icons]
Various Icons such as Sensor, User Level, Test Mode & LAN (Local Area Network) exist.
- ④ [Current Product]
It shows setting parameters, weight count and others for the current product.
- ⑤ [Bar]
It shows weight data by bar graph.
- ⑥ [Zero Adjusting]
It sets zero adjusting for the checkweigher,
- ⑦ [Weight Data Display]
It shows weight data or judging result.
- ⑧ [Menu]
You can go through the Sub menu.
- ⑨ [User]
You go to the sub menu where operation authority and security password can be changed.
- ⑩ [Screen]
You can change displaying screen.
- ⑪ [Information]
You can go to the sub menu where machine info and status can be checked.
- ⑫ [Statistics]

You can go to the sub menu for production record review menu.

⑬ [Production Quantity per Minute]

It shows production quantity per minute.

⑭ [Conveyor]

It can start or stop the conveyor. To operate it, press the button for more than a second.

1.2.1 Main Screen



Basic Main Screen

This is a basic screen of check weigher. It indicates information used frequently.

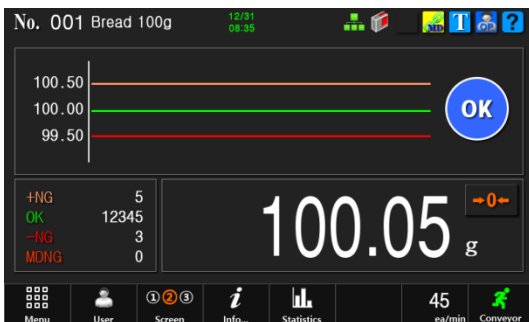

Line Graph Screen

You can check how product weight is being changed visually.



Enlarged Weight Screen

Weight data and bar graph are enlarged so that you can check them from a long distance.

1.2.2 JUDGEMENT DISPLAY

Bar Graph

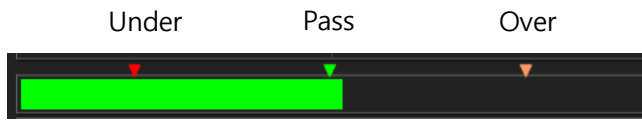

It shows weight level for testing products. 의

Line Graph

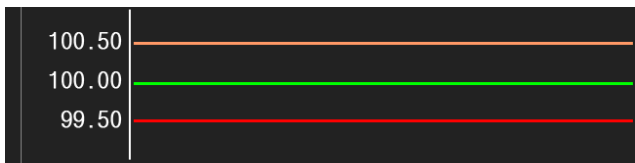









It shows weight as line graph so that you can check how product weight is being changed visually.

Judging Icon

| Icon | Explanation |
|------|---|
| | Pass Weight is between under/pass. |
| | Over Weight is more than upper limit. |
| | Under Weight is less than lower limit. |
| | External NG Foreign material like metal is detected. |
| | External NG. NG signal is received from external device. |
| | Over Maximum Weight is over maximum weight value. |
| | Under Minimum. Weight is less than minimum weight value. |
| | Double Entry More than two products pass through within weighing period. |

1.2.3 ICON

| ICON | EXPLANATION |
|---|--|
|  | <p>TEST MODE</p> <p>It is activated when test mode is on. When this mode is on, rejecting operation like conveyor stop or rejecter is not made. You can go back and forth between normal and test mode by touching this icon for more than a second.</p> <p>(Unless otherwise there is any special reason, do not turn on test mode because rejecter is not operational even for under or over weight.)</p> |
|  | <p>User Level</p> <p>It shows current user level. There is restriction for approaching and using menu depending on user level.</p> |
|  | <p>Synchronizing External Metal Detector</p> <p>It sets synchronizing the same product number with external metal detector.</p> |
|  | <p>Balance Fault (in One Screen Option)</p> <p>It shows balance status for the inside of metal detector tunnel. When it is in an error, this icon turns in red. If this error persists, please put in for A/S request.</p> |
|  | <p>Output Fault (in One Screen Option)</p> <p>When output of detecting signal is abnormal, this icon turns in red. If this error persists, please put in for A/S request.</p> |
|  | <p>Detecting Frequency (in One Screen Option)</p> <p>It shows the kind of detecting mode and frequency for a current product.</p> |
|  | <p>Sensor</p> <p>It is on whenever passing products go through the sensor.</p> |
|  | <p>LAN (Local Area Network)</p> <p>It is on when accessing to Ethernet or Serial communication program.</p> |

1.2.4 SCREEN OPERATION

Main Screen Shortcut Button

You can move to the specific sub menus directly from the main screen and set up or deactivate the specific function.

(Uses of some functions are limited depending on user level.)

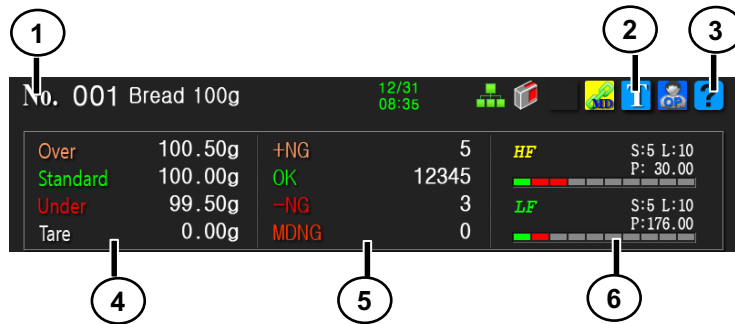

- ① If you touch [product number], you can move to [product list] directly.
- ② If you touch this icon, you can either set up or deactivate test mode by touching this icon for more than a second. When test mode is on, rejecting operation such as conveyor stop or rejecting operation cannot be used. (Please do not use Test Mode unless otherwise there is a special reason.)
- ③ If you touch this icon, you can move to the help message menu.
- ④ If you touch the area around (under/pass/over), you can move to the [product information]
- ⑤ If you touch the area around weight data, you are able to delete them.
- ⑥ If you touch the area around detection bar graph, you move to the [metal detector] menu directly.

Number Input

[Number Key] Screen pops up in case numbers should be input.

- 1) If you touch [←], the number input just before will be deleted.
- 2) If you touch [C], all the numbers input will be deleted.
- 3) If you touch [Cancel], it will return to the prior menu ignoring the previously input number.
- 4) If you touch [Ok], the numbers input will be saved and it will return to the prior menu.

Password Input

[Password Input] pops up in user log-in and changing the password.

Input numbers will be indicated as asterisk (*).

- 1) If you touch [Backspace], the number input just will be deleted.
- 2) If you touch [Clear], all the numbers input will be all deleted.
- 3) Once inputting 5 digits of password, [Password input] will disappear automatically.

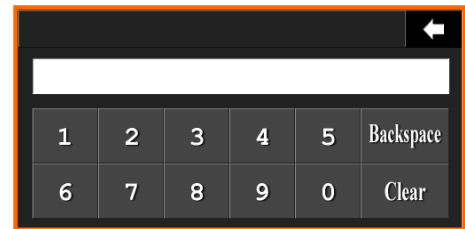

Character Input

[Keyboard] pops up when inputting the product name.

10 digits of Korean Characters, 20 digits of English/Number/Special Characters can be input.



- 1) If you touch [Caps Lock], either uppercase letter or lowercase letter is changed each other.
- 2) When inputting English character with [Shift] pressed, it will be changed to uppercase letter.
- 3) If you touch [한/영], either Korean character key or English character key is changed each other.
- 4) If you touch [Backspace], the characters input just before will be deleted.
- 5) If you touch [Space], the space of 1 character will be added.
- 6) If you touch [Enter], characters input will be saved and it will return to the prior menu.

Tap Button / List

You can go to each menu by touching each top.

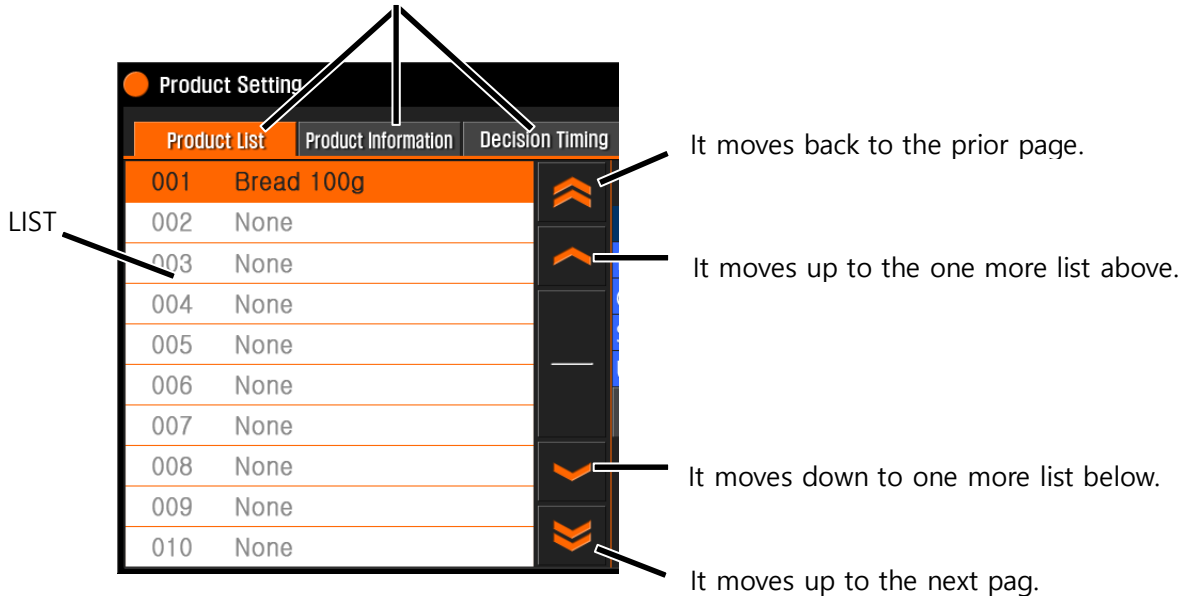

Help Message Menu

Help message is available on each screen.

- 1) If you touch either or , it goes to help message menu.
- 2) If you touch in help message scree, it goes back to the prior menu

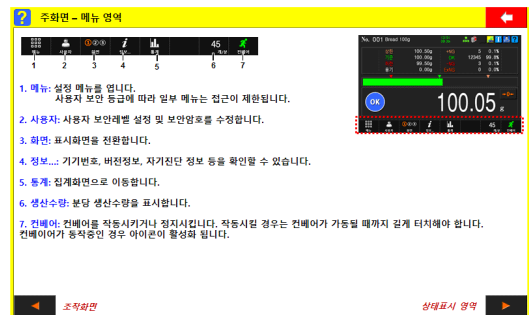

2 BASIC OPERATION

This chapter explains about basic operation.

2.1 POWER ON / OFF

Power On

If you turn power switch to right clock wise, power is on.

Power Off

If you turn power switch to left un-clock wise, power is off.



Power Switch

For more stable weighing, please turn on power 30 minute before production.

2.2 OPERATION / STOP

Operation

If you touch conveyor either conveyor button or  of main screen for more than 1 second, the conveyor starts to move for operation.

Stop

If you touch conveyor button or  of main screen, the conveyor stops..

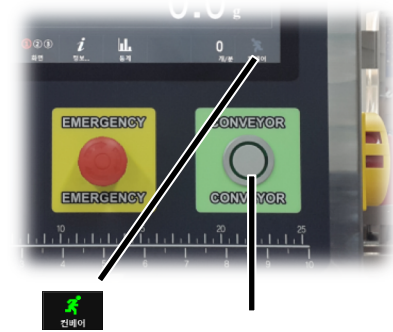

Conveyor Button

Please check if nothing is placed on in-feed/weighing/reject conveyors. Any foreign material left on the conveyor will affect weighing efficiency negatively.

2.3 ZERO SETTING

Unless otherwise weighting data is 0 when conveyor stops, please press [Zero Setting] to make it 0. However, weighing data when conveyor stops is out of zero setting range, it is impossible to make weighing data to 0 by implementing zero setting.

CAUSE OF ZERO SETTING MALFUNCTION

- When foreign material is on weighing conveyor (zero setting could be deviated.)
- When weighing conveyor touches in-feed/rejecting conveyor or neighboring other machines.
- When either lifting up weighing conveyor or putting too much pressure on weighing conveyor (load cell could be damaged.)

In case of the above, zero setting should be made again. <refer to chapter (3.10)>

If weighing data cannot go back to "0" even after zero setting, please contact with manufacturer.

2.4 USER SETTING CHANGE / PASSWORD CHANGE

There is limit on possible operating range depending on user level.

This machine provides three user levels.

User level right after turning on power is set for "USER"

- **OPERATOR:** Only basic operation functions such as Operation/Stop/Product Change are possible. Any specific password is not required.
- **QUALITY MANAGER:** Additional functions like weight adjustment, product setting & tracking management are possible. Initial password is 20000.
- **ENGINEER:** Overall system settings are possible. Initial password is 30119.



Caution

Initial password is recommended to be used after its revision

In case password is forgotten, please put in for the maker.

2.4.1 USER SETTING CHANGE

Ex) Changing to Quality Manager

- 1) If you touch [USER] button, [User Setting] menu will be on.



- 2) If you touch [Login] button after checking "Quality Manager", [Password] screen pops up.

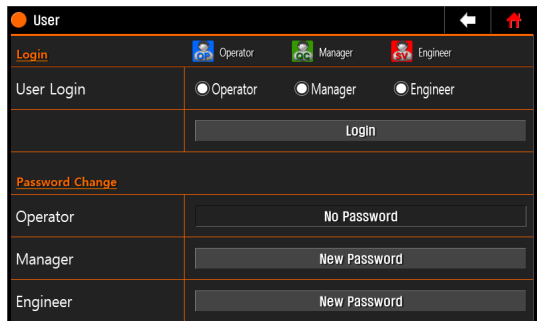

- 3) If you input password ["20000"], user level will be changed to "Quality Manager" and screen will be back to main screen.

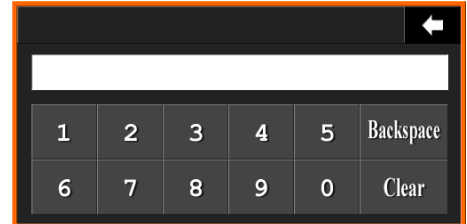

2.4.2 PASSWORD CHANGE

- 1) If you touch [New Password], [Password Change] Screen pops up.
- 2) Once 5 digits of password to change is input, [Password Change] will be shut automatically. Afterwards, changed password will be applied.

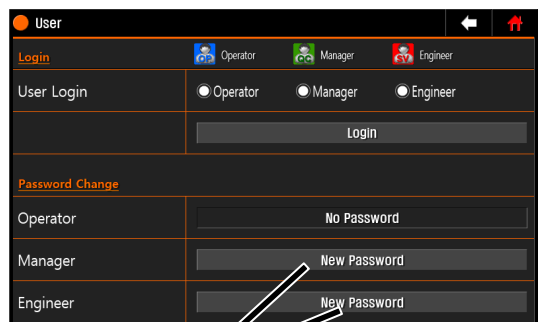

New Password

2.5 MACHINE STATUS DIAGNOSIS & CHECKING

You can check basic information and self-diagnosis result on the machine.

(Main Screen → Information)

BASIC INFORMATION

It shows machine's serial number, board version, maximum weighing capacity and etc.,

- Board version is not available when there is communication problem with the relevant board. In this case, please reboot the machine. If the problem persists, please contact the maker for A/S..

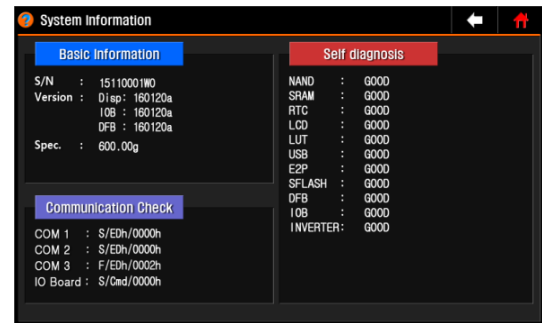

COMMUNICATION CHECK

- If there is any error in communication packet between display and IO Board, the final error will be on the display.
- If you touch around [communication check], the error will be initialized.
- If communication error occurs, the relevant command will be executed again by resending it.

Self-diagnosis

- After booting, result of self-diagnosis on the checked internal parts will be displayed. If there is any problem, it shows "ERROR" like the display on the right.
- If you see the same display as the right after booting, you will be able to check details about "ERROR" on [Information] menu.
- If you keep seeing "ERROR" on the display, please contact the local dealer or the maker for A/S.

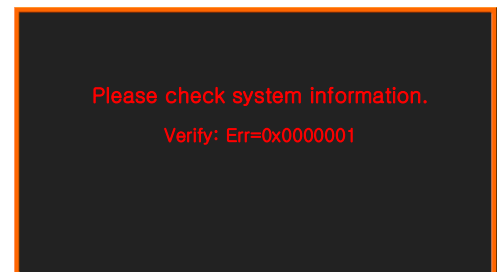

3 BASIC FUNCTION

This chapter is about basic using method.

3.1 DISPLAY DIAGRAM

This diagram is when logging-in as quality manager level.

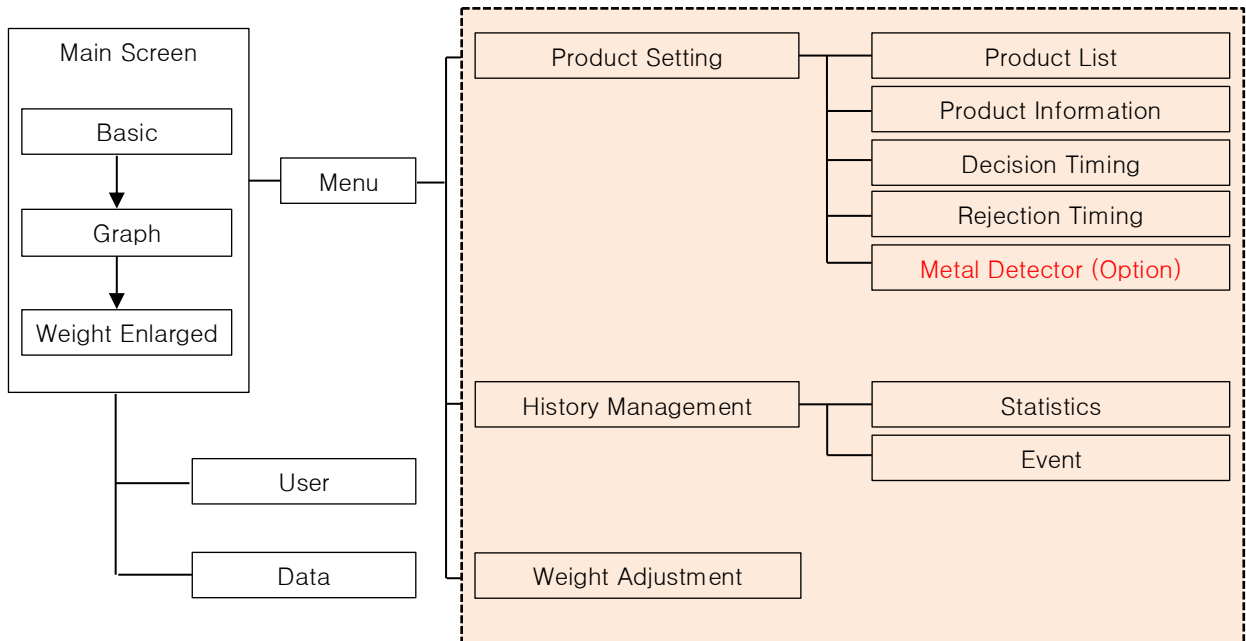

3.2 SETTING PARAMETE

This chapter is about machine setting for weighing and sorting.

3.2.1 PRODUCT LIST

(MENU → PRODUCT SETTING → PRODUCT LIST)

| INDEX | DESCRIPTION |
|--------------------|--|
| NEW REGISTRATATION | To register the product newly. If you try to register on the pre-registered product, the previous setting will be deleted. |
| PRODUCT DELETE | To delete the registered product. |
| COPY/PASTE | To copy the pre-registered product to a different product number. |
| PRODUCT CHANGE | To change to the product to test |

3.2.2 PRODUCT INFORMATION

(MENU → PRODUCT SETTING → PRODUCT INFORMATION)

| INDEX | DESCRIPTION |
|----------------------------|--|
| Prodcut Name | To register the product name. Max. letters to input is 10 letters for Korean and 20 letters for English/Number/Special character |
| Product Length | To set the length of the product to test its weight. Please input the longest length in passing wise. |
| Standard Value | To input standard value of the product to test |
| Over | Allowable tolerance of standard value (+). If weight value is more than upper limit, it will be judged as Over. |
| Under | Allowable tolerance of standard value (-). If weight value is less than lower limit, it will be judged as Under. |
| Tare Weight | If you want to deduct plate weight from total weight of the product to test, please input tare weight.. |
| Conveyor Speed | To set conveyor speed as meter per minute. Value of ea/min is automatically changed based on this setting. |
| Production Q'ty per minute | To set conveyor speed as ea per minute. Value of m/min is automatically changed based on this setting. |
| Dynamic Offset | In order for minute weighing based on the product to test, please proceed dynamic offset, which can be input manually. Basic Value is 1.00000 |

3.2.3 DECISION TIMING ADJUSTING

(Menu → Product Setting → Decision Timing)

| INDEX | DESCRIPTION |
|--------------------------|---|
| Sensor Perception (S) | The time required for the product setting by sensor. Under the judgement "Manual", it should be input by manual. |
| Stability Perception (A) | It is starting point of weighing section for product judgement. Under the judgement "Manual", it should be input by manual. |
| Judgement Section (B) | It is ending point of weighing section for product judgement from stability perception (A). It calculates the value with between the Stability Perception |

| | |
|-----------|--|
| | (A)~Judgment Section (B). Under the judgement "Manual", it should be input by manual. |
| Judgement | <ul style="list-style-type: none"> • Automatic: If you change the speed, each value for (S), (A) & (B) are decided based on the changed speed. • Manual: the user inputs (S), (A), (B) for the product manually. |

3.2.4 REJECTION TIMING

(Menu → Product Setting → Rejection Timing)

| INDEX | DESCRIPTION |
|-----------------------------|---|
| Delay Time (in msec) | It is the time when the rejecter and tower lamp starts to operate right after judgement of weight.. |
| Operating Time (in msec) | It is the time how long the rejecter and tower lamp will be operated after delay time. |

3.2.5 METAL DETECTOR

For one screen combi model (please refer to the chapter 3.8 for metal detector setting)

3.3 PRODUCT REGISTRATION

At most, maximum 100 kinds of products can be registered.

Please prepare the standard product sample in advance.

1) PRODUCT NUMBER CHOICE

- If you touch [product setting] from [menu], [product list] will be on the screen.
- After choosing product number to register, please start product registration by touching [Product Registration].

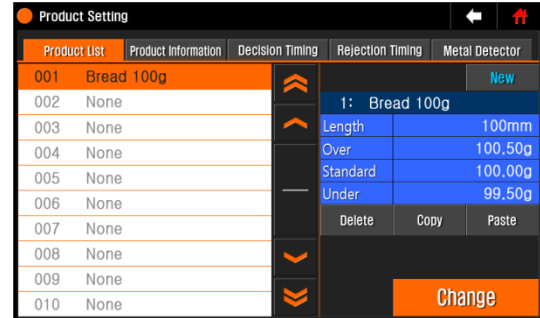

2) INPUT OF PRODUCT NAME AND LENGTH

- If you touch around where to input product name, [key board] will pop up. Then, please touch [Enter] after inputting product name.
- If you touch around where to input product length, [number key] will pop up. Then, please touch [OK] after inputting product length.
- Please touch [next] after checking if both product name and product length were properly input.

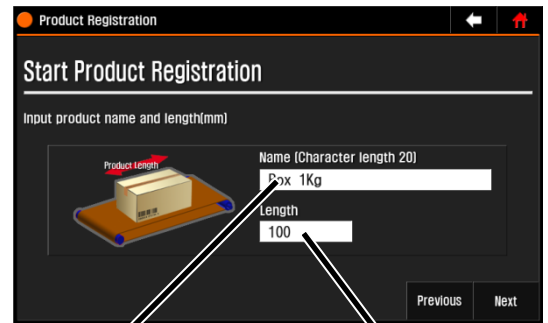

PRODUCT NAME

PRODUCT LENGTH



Product Name and Product Length are must-input.
 In case of the product length, you can use measuring tape affixed on the front control tower.

3) Input Product Weight

- Please input values for Pass, Under & Over each..
- For Over and Under, you can input either weight value itself and deviation. If either of them is input, the other data will be completed automatically.
- If necessary, please input tare weight. If you input weight on main screen, the weight after deducting tare weight will be on the screen.
- If you complete input, please touch [next].

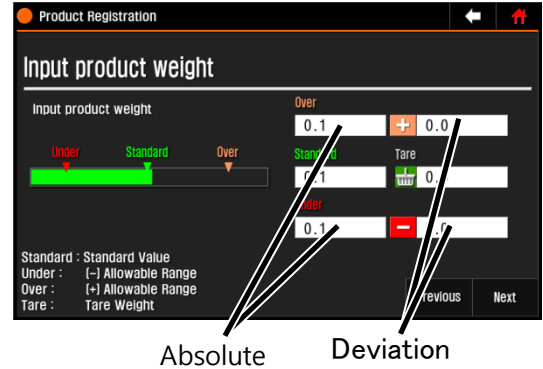

4) Input Conveyor Speed

- You can set up conveyor speed by inputting either production quantity per minute or belt speed.
- Inputting production quantity per minute calculates belt speed automatically.
- Inputting belt speed calculates production quantity automatically.
- If you touch [next], product registration will be completed.

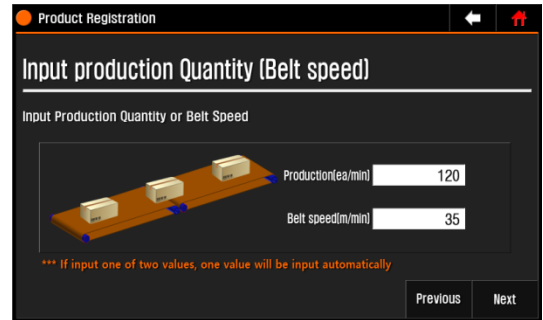

5) Product Registration Completed

- Each setting menu can be seen on the screen.
- If you touch [completed], production registration will be completed.
- If you touch [dynamic offset], it will start.
(Please refer to 2.6 for dynamic offset.)

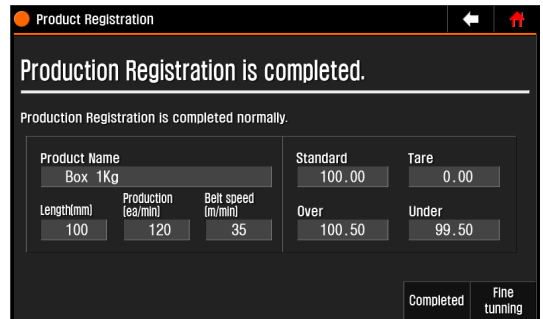

Dynamic Offset Value is the constant to calibrate the measured value while the conveyor is moving close to that when it stops in case two of these values are different to each other.

3.4 PRODUCT CHANGE / DELETION / COPY

(Main Screen → Product Setting → Product List)

3.4.1 PRODUCT CHANGE OR DELETION

Please choose the product to weight on the product list.

- Product Change: to change the product by touching **[Product Change]** on the screen.
- Product Deletion: to delete the product by touching **[Product Deletion]**. But, the currently testing product cannot be deleted.

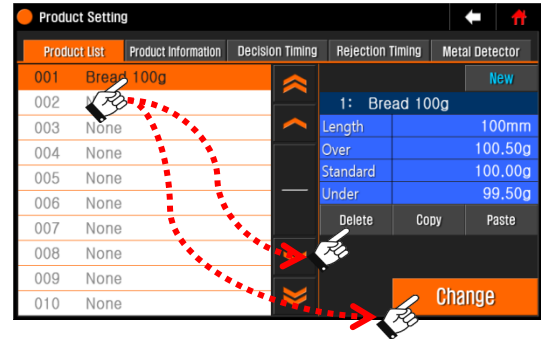

3.4.2 COPY

You can copy and use the setting value of the previously registered product.

- 1) Please select the product number from the product list, and then touch **[Copy]**.

i You cannot copy the data (Product quantity, N.G).

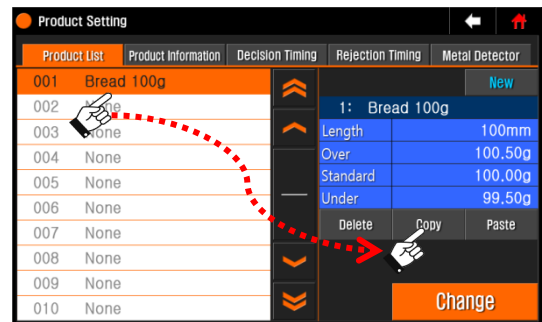

- 2) Please select the product number for copy from the product list, and then touch **[Paste]**.

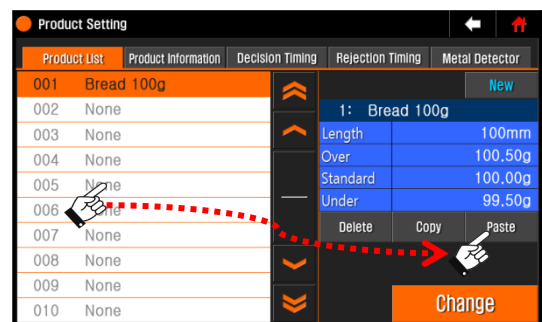

- 3) When the copy is complete, the product list will be updated.

3.5 DYNAMIC OFFSET

Dynamic Offset Value is the constant to calibrate the measured value while the conveyor is moving close to that when it stops in case two of these values are different to each other.

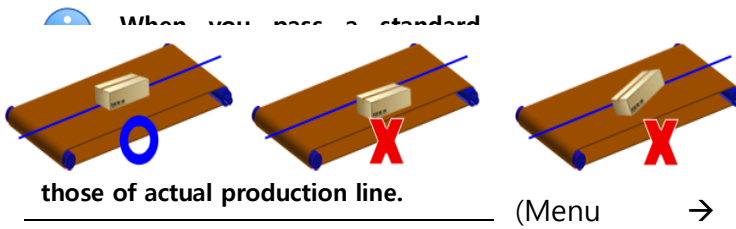

Product Setting → Product Information)

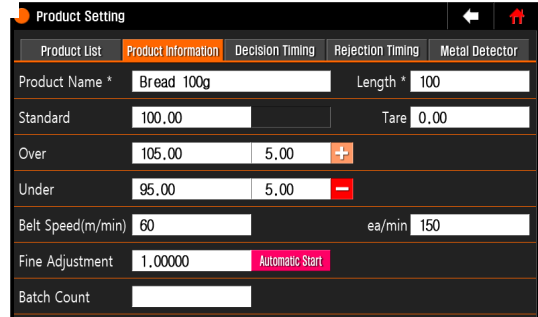

1) DYNAMIC STARTS

- Start Dynamic Offset by touching [Automatic Start].
- 영점조정을 실행 후 단계를 표시합니다.

2) INPUT WEIGHT OF STANDARD PRODUCT

- Input weight on specification of standard product as standard weight.
- Operate the conveyor by touching [Conveyor].
- Start Fine Tuning by touching [Start].

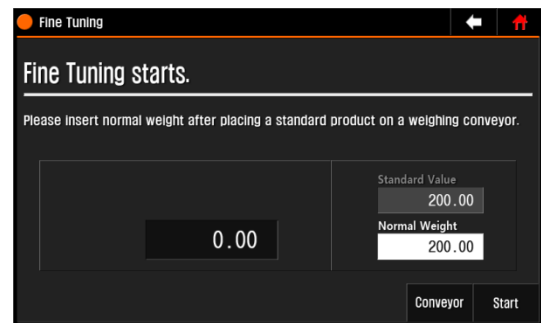

3) PASS STANDARD PRODUCT

- Pass a standard product on the conveyor by 10 times according to instruction on the screen. Dynamic offset is completed once [Fine Tuning is completed] is on the screen after passing it 10 times. Please touch [Complete].
- You can complete fine tuning by touching [next] if passing a product for 5 times. (10 times is recommended.)

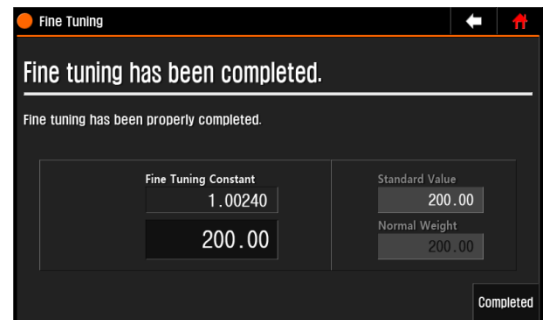
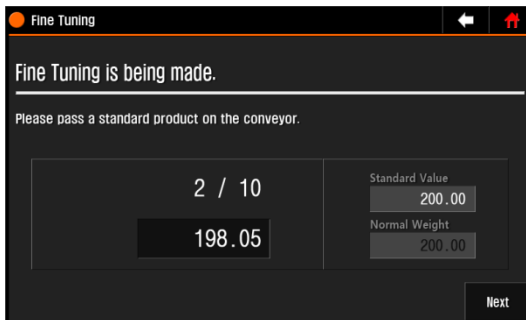

3.6 DECISION TIMING

Adjust decision timing in order to raise up weighing accuracy of the product. This machine can automatically calculate decision timing if product length is input. If error range is within tolerance, adjusting decision timing is not necessary. More minute weighing is possible by making fine tuning of timing parameter.

CAUTION

On decision timing screen, weighing and rejecting action is not made.

(Menu → Product Setting → Decision Timing Tab)

INPUT PRODUCT LENGTH

- Input product length by touching the screen around where product length was input. If product length was already registered, you will not have to input it again.
- Input the longest length of the product at entry direction.

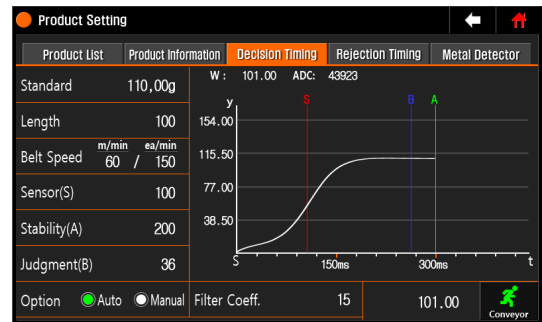

ADJUST TIMING

- If passing the product, wave in on the screen. Adjust to make both stability perception (A) & sensor perception (B) to let stabilized section situated between (A) and (B).
- If you set judgement at [Auto], Sensor Perception (S), Stability Perception (A) & Decision Section (B) go back to original values.

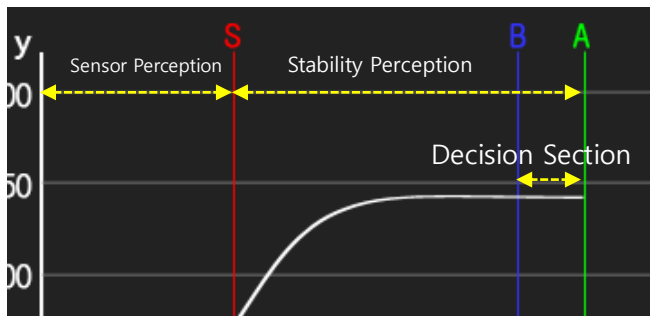

If product shape is unique, double entry sign might be on even by passing the product one time. In this case, please increase sensor perception (S) a bit more decrease stability perception (A).

3.7 REJECTION TIMING

There is rejection timing for delay/passing time for each product.

(Main Screen → Product Setting → Rejection Timing)

Ex) Delay Time=500ms, Passing Time=500ms

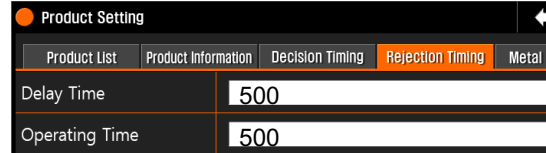

Please refer to [4.3 output port setting] for delay and passing time for output signal. Please only set delay/passing time unless otherwise in case of special cases (Ex. Multiple rejection).

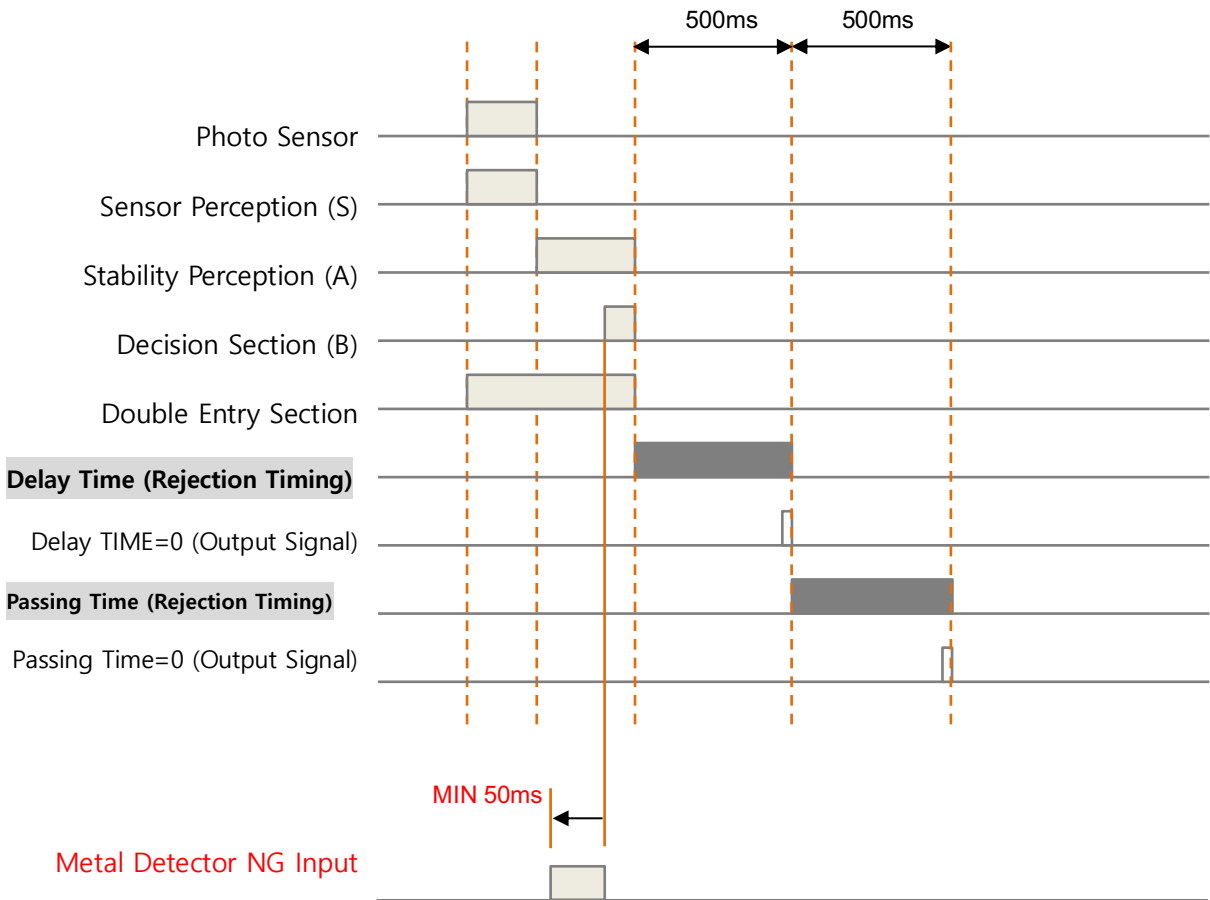

3.8 METAL DETECTOR SETTING (OPTION)

Adjust metal detector setting for one screen combi model (checkweigher/metal detector same screen)



If you want to use the machine for one screen combi model, machine setting will be needed. This setting should be set by the maker before ex-factory.

(Menu → Product Setting → Metal Detector)

| Index | Description |
|--------------------|---|
| Detection Speed | If a metal detector is a normal conveyor type, please choose Low . If a metal detector is a fall type, please choose Mild . And, if there is a special case requiring maximum detection speed, please select High. However, if you select High, the ambient noise removal software stops working internally so that the noise effects may be increased. |
| Threshold | It is minimum maintaining time of the signal over detection level to be regarded as metal detection. Only if the signal over detection level is more than a certain period of time to be set as Threshold, it is acknowledged as metal detection. |
| Detection Interval | It is time setting on how long next metal detection is set to ignore from the time of metal detecting. |
| Delay Time | It is a stand-by time before sending metal detection signal to the checkweigher. If it is too short or long, the metal detector might not be able to make metal detection correctly. (Refer to Rejection Timing 3.7) |
| Frequency | Select right detection mode depending on the type of testing product. There is more explanation on the next page. |
| Detection Level | Adjust horizontal detecting level on the graph. If detecting signal is over this detecting level, it is regarded as metal detection. In case of dual frequency mode, another detecting level ("LF") is on the screen. |
| Sensitivity | Make adjustment while reducing sensitivity not to make the maximum value of the graph exceed 50% of the screen by passing the product and observing the graph of the detection. In case of dual frequency mode, another sensitivity adjusting section ("LF") is on the screen. |
| Phase | Adjust phase at the value where the graph becomes the smallest by passing the product and observing the graph. Each frequency channel has its own color. For example, make adjustment by referring to yellow graph for HF and green graph for LF. |
| Auto Setup | Set detecting frequency, phase, sensitivity automatically. |

Frequency Setting

| Frequency | Description |
|-----------|--|
| AL | Low-frequency signal to be used. Suitable for products containing small amount of metal components such as aluminum-deposited packaging products |
| D1 | Mid-frequency signal to be used. Suitable for a small amount of water/salt containing products |
| D2 | High-frequency signal to be used. Suitable for a water and salt-free dry product |
| W1 | Low/mild-frequency mixed signal to be used. Suitable for a product with high water/salinity |
| W2 | Low/high-frequency mixed-signal to be used. Suitable for a product with low-water/salinity |
| HW1 | Low/mid-frequency mixed-signal to be used. Suitable for mass products with high-water/salinity |
| HW2 | Low/high-frequency mixed-signal to be used. Suitable for mass products with high-water/salinity |

3.8.1 AUTO SETUP

- 1) Select [Auto Setup].
 ** "Without Sensor" is default for auto setup.
 When using sensor is difficult, select "Without Sensor".

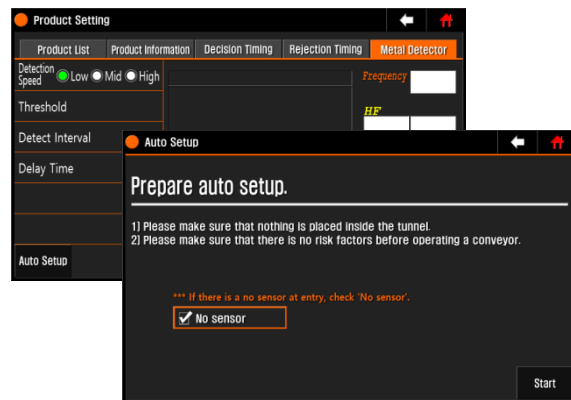

- 2) For the next step, select detecting mode. Choose [Auto] or [Manual]. If you already know product phase, you can choose detecting mode manually.

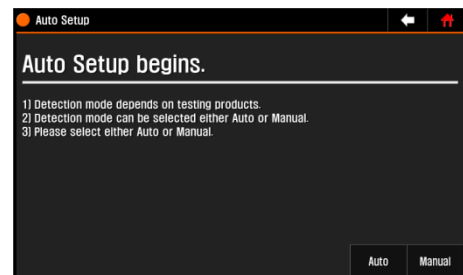

- 3) Afterwards, proceed as instruction on the screen. Passing time of the product to pass is different depending on its product effect. The higher product effect (high-water/salinity), the more passing time for auto setup is required.

3.9 PRODUCT RECORD

3.9.1 STATISTICS

(Menu → Record Management

→ Statistics)

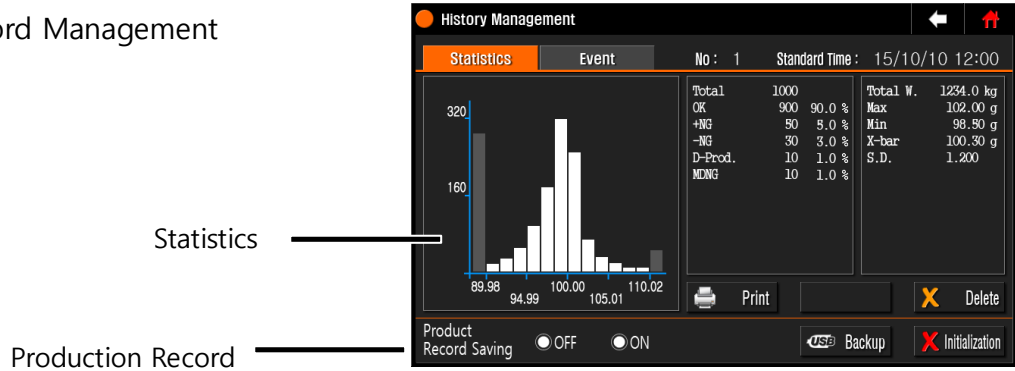

1) STATISTICS

OUTPUT

You can print out the product record through the printer..

| | |
|-------------------------|----------------------------|
| PNO. : 1 | Product Number |
| START: 2016-01-01 09:00 | Statistics Start Date/Time |
| END : 2016-01-20 17:00 | Statistics End Date/Time |
| TOTAL W. 1234.0 Kg | Total Weight |
| MAX 102.00 g | Max Weight |
| MIN 98.50 g | Min. Weight |
| AVG 100.30 g | Average Weight |
| SD 1.2000 | Standard Deviation |
| TOTAL 1000 | Total Production Quantity |
| OK 900 90.0% | Standard Weight Quantity |
| +NG 50 5.0% | Over Weight Quantity |
| -NG 30 3.0% | Low Weight Quantity |
| DBLF 10 1.0% | Double Entry Quantity |
| MDNG 10 1.0% | Metal NG Quantity |
| Standard 100.00g | Standard Weight |
| Under 99.50g | Under Weight |
| Over 100.50g | Over Weight |
| Tare 0.00g | Tare Weight |

** In "EC Tolerance System mode", Batch log saved in the memory will also be printed out.
 Batch log will be saved up to maximum 100 and if 100 is all saved, there will be no more save.

DELETE

You can delete statistics data of currently produced products (or saved total products).

2) Production Record

Production Record Saving

If you set it "ON" production record will be saved into internal memory. Default is Off.

BACKUP

If you touch [Backup], pop-up screen is on.

After backup, choose check-box to delete internal memory.

You can save all production record of up to now to USB memory.

File Name: LOG_160101132025.CSV

(Saved at 25 seconds 20 minute 13 hour on 1th of January 2016 year)

You can review backup file through memo sheet or Microsoft Excel

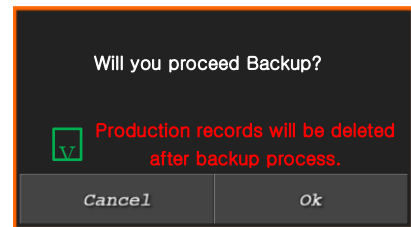

Initialization

If you touch [Initialization] button, a popup screen to ask whether to delete it or not is on the screen

You can initialize all the data related with production record by touching [Ok].

3.9.2 EVENT

(Menu → Production Record Management → Event)

Event can be saved up to maximum 1,000 pieces. Afterwards, older data will be deleted earlier and new event will be recorded.

BACKUP

If you touch [Backup] button, a popup screen to ask whether to delete it or not is on the screen.

All the event of up to now are saved into USB memory.

File Name: E-LOG_160101132025.CSV

(Saved at 25 seconds 20 minute 13 hour on 1th of January 2016 year)

you can review backup file through memo sheet or Microsoft Excel.



DELETE

Delete all the saved event.

3.10 WEIGHT ADJUSTMENT

If weight on the screen is differ from test weight or standard weight, make weight adjustment.

(Menu → Weight Adjustment) or (Menu → Scale Setting → Weight Adjustment)

1) Weight Adjustment Starts

- If weight adjustment starts is on the screen, empty weighing conveyor and touch [Start] to start weight adjustment.
- After zero setting, next stage will be on the screen

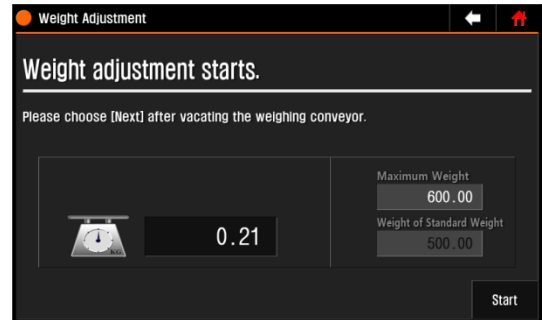

2) Test Weight Input

- Calculate dynamic offset constant by inputting test weight input supplied by maker and touching [Next].
- Once weight adjustment is completed, please touch [Completed] to go back to the prior menu.

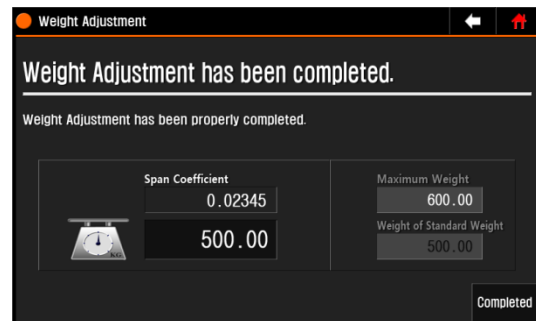
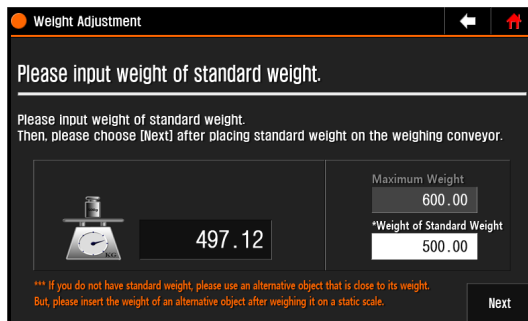

4 ADDITIONAL FUNCTION

It explains you on how to use each function of the machine.

4.1 SCREEN LEVEL TREE

This level tree is in case the machine is logged in as engineer level.

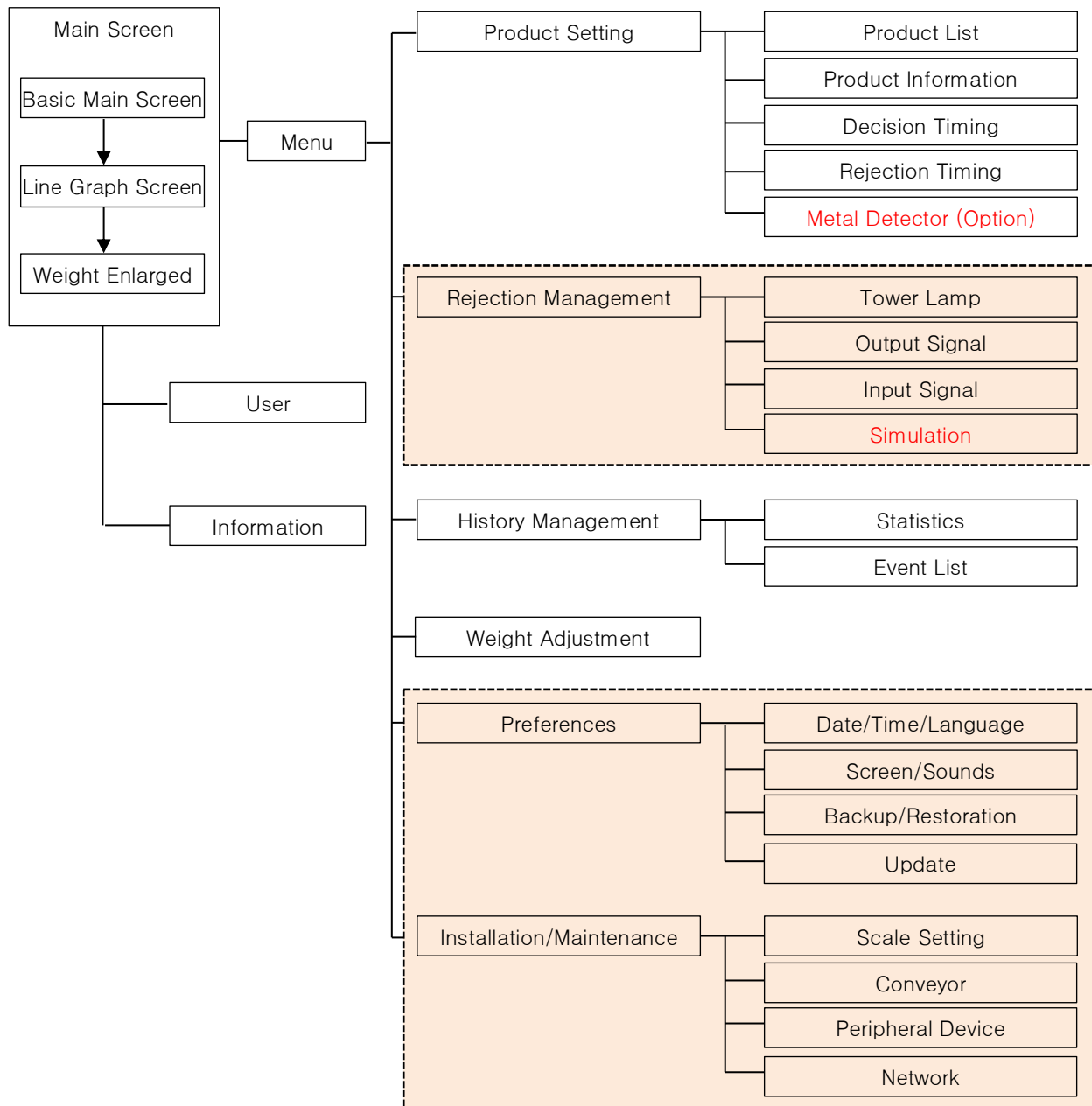

4.2 SETTING PARAMETERS

It defines main setting parameters.

4.2.1 REJECTION MANAGEMENT

(Menu → Rejection Management → Tower Lamp & Output Signal & Input Signal)

Kind of Output Signal.

| Kind | Description |
|---------------------------|---|
| Pass | Relevant Signal for each judgement goes out. |
| Over | Cf) MDNG, Outer NG & Double Entry do not follow the below priority. [Output Priority] |
| Under | |
| MDNG | Alarm > MDNG = Outer NG > Double Entry > Pass = Over = Under |
| Double Entry | It goes out in case receiving metal detection signal. |
| Outer NG | It goes out in case double entry is checked. |
| Conveyor Moving | It goes out in case outer NG signal is received. |
| DOUBLE NG | It goes out in case the conveyor is being operated. In this case, delay time and passing time are ignored. |
| ETC 1 | It goes out in case the number of errors input for DOUBLE NG setting occur. |
| ETC 2 | For Expandable Preliminary use |
| ETC 3 | For Expandable Preliminary use |
| Machine Malfunction Alarm | (Option.) |

Kind of Input Signal

| Kind | Description |
|-----------------|---|
| Outer NG | Outer NG Signal Set input ON time by more than 100ms at the outer device. |
| Conveyor Moving | Operation Start Signal Set input ON time by more than 100ms at the outer device. |
| Conveyor Stop | Operation Stop Signal |
| Interlock | For Expandable Preliminary use |
| Option A | For Expandable Preliminary use |

| | |
|----------------|---|
| Option B | For Expandable Preliminary use |
| Option C | For Expandable Preliminary use |
| Option D | For Expandable Preliminary use |
| Reject Check | Sensor to check if contaminant products go in to the reject bin It occurs in case the product is acknowledged. |
| TOP COVER OPEN | It occurs in case top cover is opened. |
| BIN FULL | It occurs in case bin is full. |
| BIN OPEN | It occurs in case lockable device of the bin is open. |
| Air Pressure | It occurs in case air pressure level of the rejecter goes down to a certain level. |

Delay Time/Operating Time/Operating Method/Logic

| Kind | Description |
|--------------------------|--|
| Delay Time | It sets delay time before output begin. |
| Operating Time | It sets remaining time of signal and is only valid in case operating method is set at Pulse. |
| Operating Method | <ul style="list-style-type: none"> Pulse: It remains ON status during operating time. Hold: It sustains current status until judgement for the next product to test is terminated. |
| Logic | It sets when to begin the event for input signal. <ul style="list-style-type: none"> L: When signal becomes ON from OFF. H: When signal becomes OFF from ON. |
| Reject Confirmation Test | (Option) It sets the mode to test Reject confirmation Sensor. |

4.2.2 PREFERENCES

(Menu → Preferences → Date/Time/Language & Screen/Sounds & Backup/Restoration & Update)

It defines basic information related with machine operation and function such as system update.

CAUTION

In case of changing System date, detection history should be initialized. System date is criteria of detecting history data management so that changing it will result in errors in data.

| Kind | Description |
|-----------------------|---|
| Date | It registers system date. (in YYYYMMDD) |
| Time | It registers system time. (in HHMMDD, 24 Hour) |
| Language | It sets languages for each country. Other foreign language can be added through additional work upon request of customers. |
| Screen | It sets initial screen type when the machine is booted. <ul style="list-style-type: none"> • Basic: Basic screen and the most popularly required data will be shown. • Graph: Can check transitional change in weight of products to test by graph. • Weight: Easy to check weight data from a long distance due to enlarged weight data and bar graph. |
| Judgment Display Time | It sets time to display judged weight on the screen. In case [Off] is set, it maintains current screen until newly judged weight data are received. |
| Sound Effects | <ul style="list-style-type: none"> • Notification: If you tick Notifications, it beeps sound in the case of power on, work completion and etc., • Touch: If you tick Touch, it beeps sound when the button of LCD screen is touched • Judgement: If you tick Judgement, it beeps sound when it weighs a product and judgement. • Error: If you tick Error, it beeps sound in various situation of errors. |
| Weight Indication | It defines how to indicate weight on main screen. <ul style="list-style-type: none"> • Weight: It shows absolute weight. • Deviation: It shows Deviation (Absolute Weight – Standard Weight) weight. |
| Touch Calibration | It resets touch coordinates of LCD screen. |

| | |
|-------------------------------------|---|
| Backup of Internal Memory Data | Data is saved to internal memory. Its saving process is displayed on a pop up screen. |
| Restoration of Internal Memory Data | It reads up data saved into internal memory. Once recovery is completed, the machine reboots the power. |
| USB Backup | Data is saved to USB Disk. Its saving process is displayed on a pop up screen. |
| USB Restoration | It read up data saved into USB memory. Once restoration is completed, the machine reboots the power. |

4.2.3 INSTALLATION/MAINTENANCE

(Menu → Preferences → Scale Setting & Conveyor & Peripheral Device & Network)

CAUTION

Please do not change original setting for the below since they were already set properly by the maker when ex-factory. If you need to change any setting, please put in for A/S to any authorized local technician or the manufacturer.

| Kind | Description |
|-------------------------|--|
| Maximum Weight | You can input the Maximum Weight. If you change this value, it must be set again through the Weight Adjustment. |
| Weight Indiction Unit | You can choose the Weight Indication Unit. If you change this value, the standard weight must be set again through the Weight Adjustment. |
| Decimal Point | You can choose the Decimal Point that shows on screen. If you change this value, the standard weight must be set again through the Weight Adjustment. |
| Minimu Setting Interval | It sets the indication unit that shows on screen. It is the last digit of weighed value. (ex. In case of setting to 2, it shows as 2, 4, 6, 8, 0) |
| Automatic Start | Once this function is selected, the conveyor starts to operate automatically after power is on and internal stabilization is completed. |
| Stop Mode | It stops the conveyor when chosen weight judgement occurs. <ul style="list-style-type: none"> • Weight NG: Over, Under, +OVF, -OVF • Outer NG: when Outer NG signal is received • Double Entry: when double entry occurs • Double Error: When consecutive error occurs for number of times input |
| M&S | (Option) It is used for the conveyor designed by European M&S (Mark & Spencer) specification. |
| Flip bar run-time(sec) | (Option) It sets Safety operating time of the flip bar for the conveyor desinged by European M&S (Mark & Spencer) specifiction. |
| EEC | (Option) |

| | |
|-----------------------------|---|
| | It sets whether or not to use EEC function. |
| Tolerance | (Option) It is used when EEC function is activated. |
| Printer Option | It sets printer option. <ul style="list-style-type: none"> • Not using: Printer is not used. • Metal Detector: It only prints out for Metal NG. • Checkweigher: It only prints out for weighing judgement. • Metal+Checker : It prints out for both Metal NG & weighing judgement. ** [Time Setting]: It synchronize both times for system and the printer. |
| Communication Speed Setting | It sets communication speed of 3 ports connected to the external device. <ul style="list-style-type: none"> • COM1: Operating Motor Controller • COM2: Printer • COM3: Debugger Application of communication ports might be different depending on the requirements of the machine. |
| DHCP | If the network supports IP automatic setting function, you can make IP setting assigned automatically. You will have to consult with a network manager for proper IP setting values. Inputting IP address, subnet mask and gateway are limited once "Obtaining an IP Address automatically" is set. After making change, reset Network by touching. |
| IP Address | It sets IP Address of the machine. 예) 172.016.50.4 |
| Subnet Mask | It sets Subnet Mast of the machine. 예) 255.255.255.000 |
| Gateway | It sets Gateway of the machine. 예) 172.016.050.254 |
| Port Number | It sets Port Number of the machine. |
| Sever IP Address | It sets Server IP Address of the remote server. |
| Server Port Number | It sets connection port number of remote server. |
| Connection to Remote Server | It tries to access to the port of server IP Address. |

Output Port (Tower Lamp) Setting

It sets signal to send out to output port and delay/operating time.

You can additionally set delay/operating time for output signal by this machine. Setting of the Tower Lamp is the same as that of output signal for standard ports (OUT1~8).

1) OUTPUT SIGNAL SELECT

Designate output signal.

- If you touch the area of output signal to set up, [signal kinds] window pops up.
- You can set maximum 5 kinds of output signals as duplication.

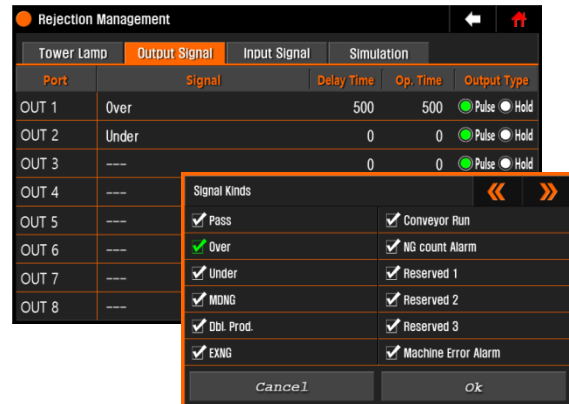

2) DELAY/OPERATING TIME SELECT

If you additionally need delay/operating time, you can set these up.

- If you touch the area of delay or operating time for the port to set, [number window] pops up.
- After inputting Time, select [Ok].

3) OUTPUT TYPE SELECT

Select output type.

- Pulse: It maintains ON status for operating time.
- Hold: It maintains current status until the end of judging for the next product to test

4.2.4 TIMING DIAGRAM FOR PORT SETTING

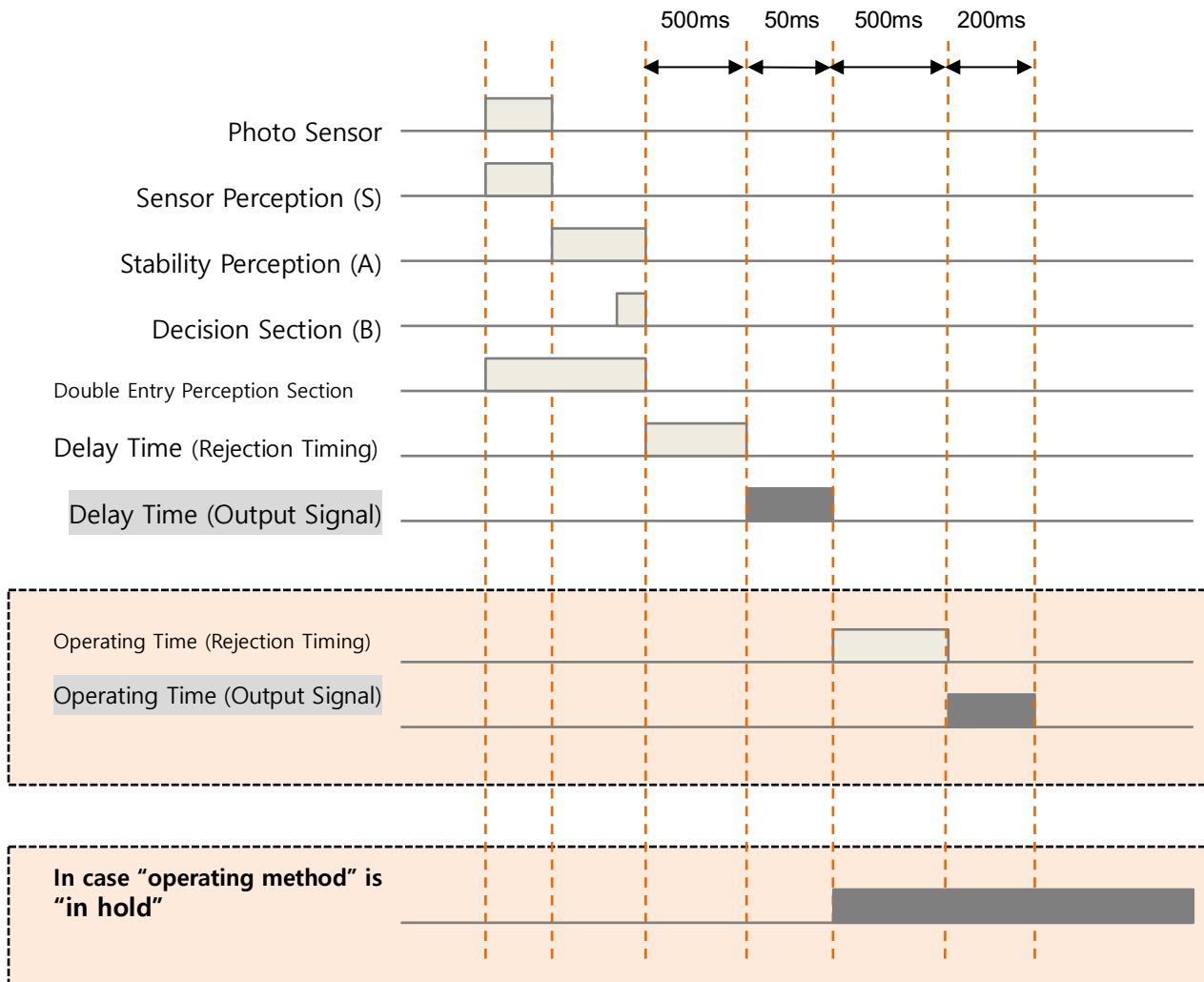

4.3 TOUCH CALIBRATION

Reset the touch coordinates of the LCD screen.

(Main Screen → Preferences → Screen/Sound)

- 1) Touch [Calibration Start].
- 2) Touch [Ok] once the right pop-up screen appears on the screen.
- 3) Touch along "+ shape" by using of the thin end (such as ball point pen and etc.,).
- 4) It should be done as the below order.
 - Upper Left Corner
 - Lower Right Corner
 - Right Center

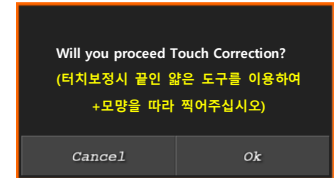

- 5) When this work is done, it saves calibration value and returns to the main screen.

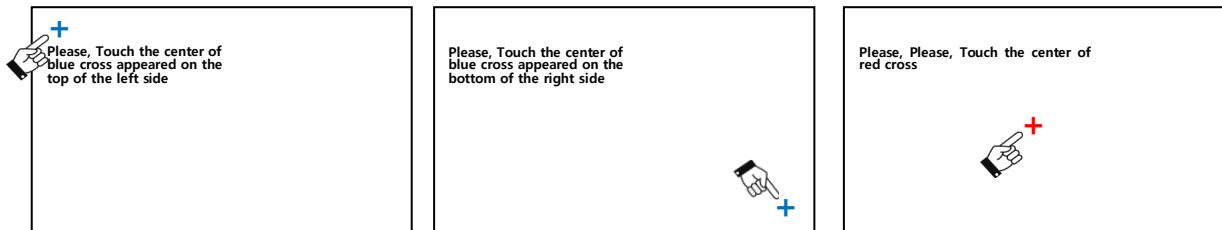

i If touch calibration is not in a normal condition, machine operation might be impossible.

The machine is shipped after touch calibration is completed so that please do not change it unless otherwise there is a special case.

4.4 BACK UP AND RESTORATION OF DATA

If previously set data are erased or the display module has to be replaced, please back up what are currently set up and restore them.

(Main Screen → Preferences → Back up/Restoration)

DESIGNATE BACK UP AND RESTORED FILE NAMES

You can designate file names when making back up and restoration. File names is taken after machine numbers unless otherwise separately appointed.

Ex) If File name(or machine number) is 2345678, :
 "12345678.DAT"

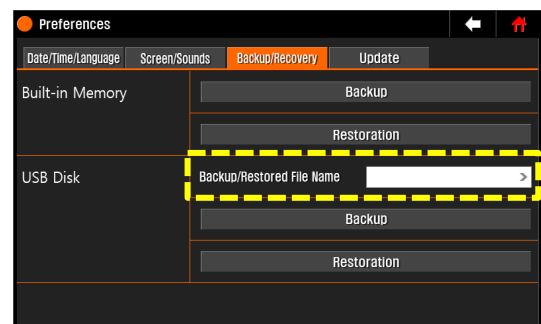

BACK UP

Save currently registered machine data, product list, setting parameters and etc to the USB memory.

Ex) If File name(or machine number) is 12345678, "12345678.DAT"



Just in case, you are recommended to back up currently registered data before starting the machine.

BACK UP

It restores back to what was previously back up. In this case, previous setting data will be all deleted. Put the USB memory to the machine before restoration.

If file error comes up when restoration, please check if there are back up files on the USB.

If files exist, please set [backup/restored file names] as the relevant file name.

4.5 FIRMWARE UPDATE

It upgrades internal program.

(Main Screen → Preferences → Update)

CAUTION

Please do not separate an USB Disk or turn off the power during upgrade process.

Please use the firmware that were only given by the purchasing office or maker.

If you download any normal firmware that you have got to the machine, fatal error might occur.

UPDATE

Please insert USB before starting update.

The relevant firmware should be in ROOT directory of the USB memory.

1) If you choose the file to update, the popup screen to ask whether or not to proceed will appear on the screen.

2) Choose [Ok].

Update process will be on the screen and the machine is rebooted once completed.

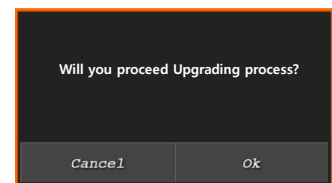
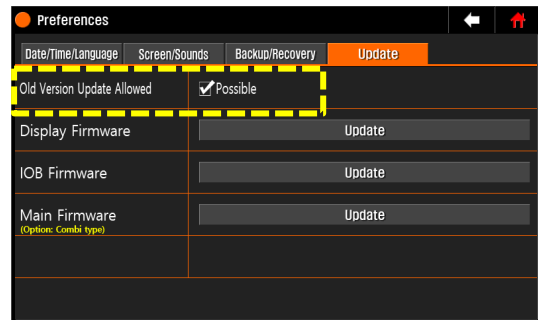

When you upgrade the machine to a former or the same version, please tick possible at Old Version Update Allowed..

4.6 SCALE SETTING

It sets Maximum Weight, Weight Indication Unit, Decimal Points and etc.,

(Main Screen → Installation/Maintenance → Scale Setting)

- 1) Set Maximum weight.
- 2) Choose weight indication unit between g or kg.
- 3) Set Decimal Point.
Ex) If decimal point is 0.1 and weight indication unit is 2, weighing data is calculated as multiple number of 0.2.

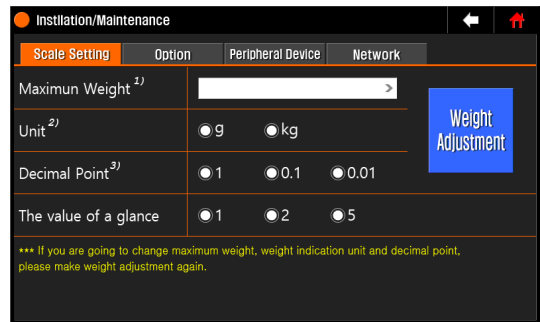

- 4) Once setting is done, implement weight adjustment by touching [weight adjustment].

i Please restart weight adjustment process after you change maximum weight, weight indication unit and decimal point.

5 INSTALLATION

It explains initial installation, commissioning and transporting method of the machine.

5.1 INSTALLATION PLACE SELELCT AND TRANSPORTAITON

5.1.1 INSTALLATION PLACE

- There should be no vibration and the surface should be flat.
- Surrounding temperature should be around 0 ~ 40°C.
- Humidity should be around 30~80%
- The Place not affected by wind from outside and without air conditioning and fan
- The place with little dust
- The place without a direct ray of light

5.1.2 TRANSPORTATION

- Please do not apply shock or damage to the weighing conveyor since it is directly connected to the scale so that the scale might be damaged.
- The location of prop for the pork lift is under the stainless frame as the right picture on the bottom.

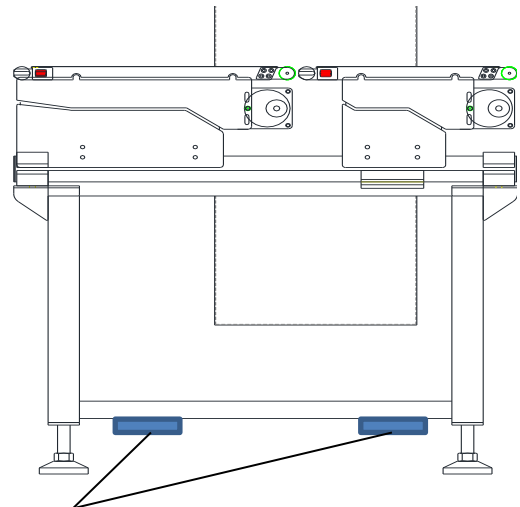

Prop for the pork lift

5.2 INSTALLATION

5.2.1 ASSEMBLE WEIGHING CONVEYOR

- 1) Assemble upper case base with the motor assembled
(Hexagonal Bolt: M6x15 → 2 ea)

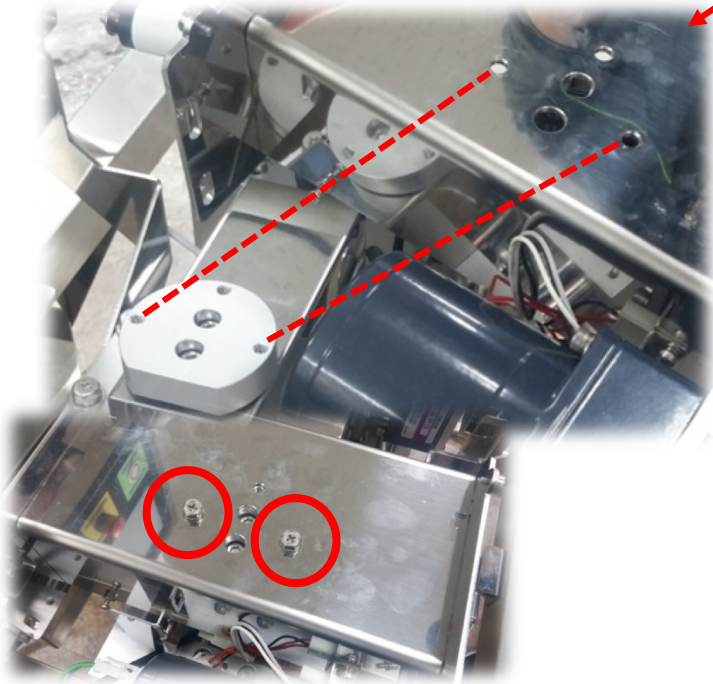

Assemble hexagonal bolts on two of holds as the above and left pictures.

- 2) Additionally assemble pins not to leak water and other foreign material into brackets assembled into the loadcell as the above and right pictures.
(Hexagonal Bolts: M6x15 → 1 ea)



- 3) Connect the motor connector (A) to the connector (B) fixed to the main body as the right picture.

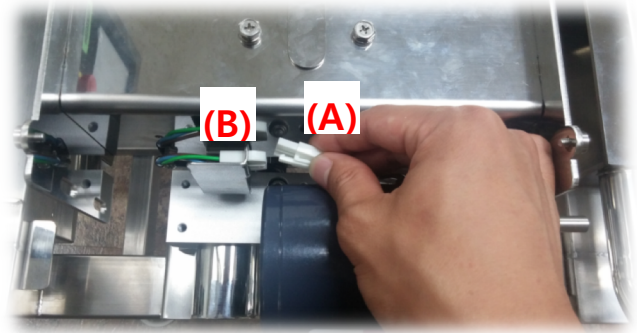

- 4) Connect a motor pulley and a timing belt before putting the conveyor unit.

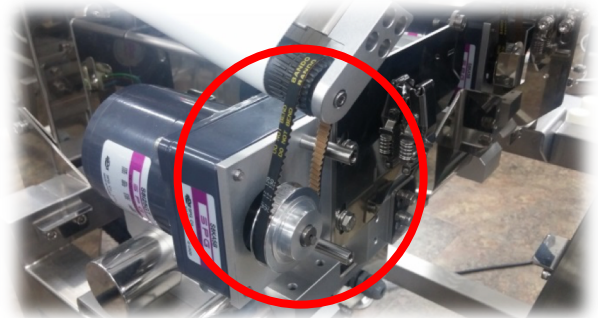

- 5) Place the conveyor unit slowly to the rack pins as the right picture.

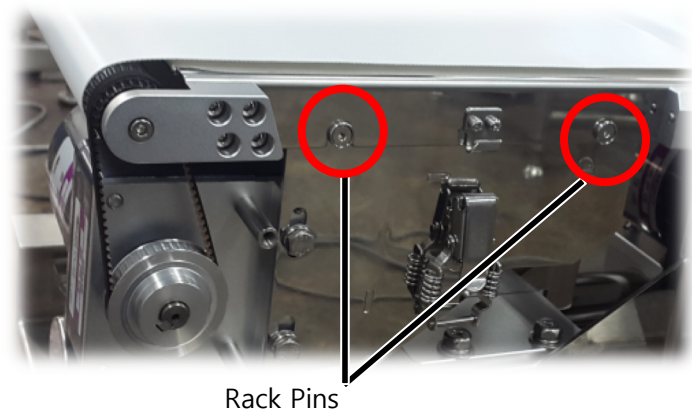

6) Lock both lockable pins.



7) Assemble the reducer cover by wrench bolt.
(wrench bolt: M5x12 → 2 ea)



8) Assembly is completed.

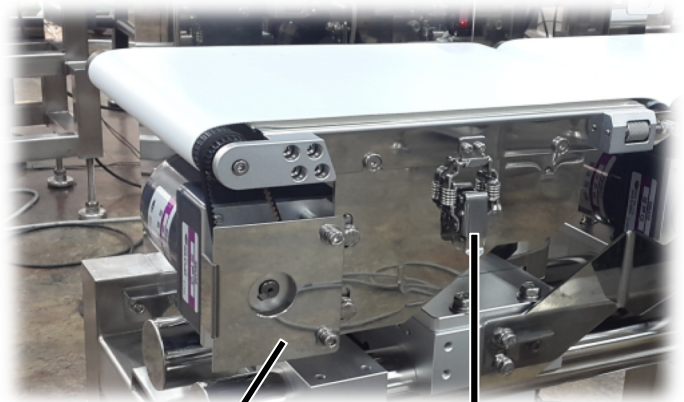

Reducer Cover

Lockable Pins

5.2.2 FIXATION OF ADJUSTING LEGS

- 1) Loosen lock nuts of adjusting legs by spanner

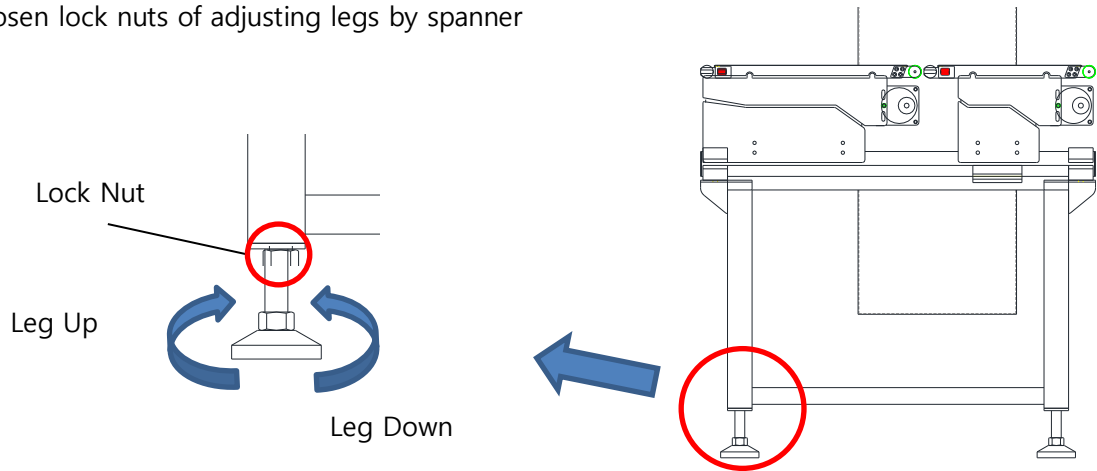

- 2) Align the conveyor height with up/down streaming conveyors by adjusting lock nuts.
 Make the product pass smoothly by aligning the height of in-feed/weighing conveyor but do not let both touch each other

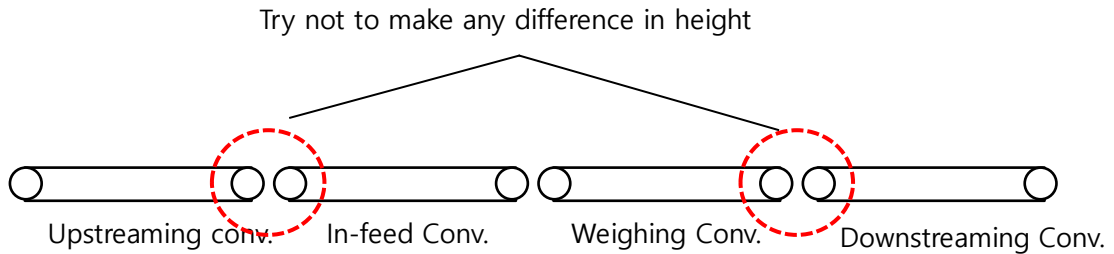

- 3) Fix the conveyor by locking lock nuts of adjusting legs.

5.2.3 CONNETION TO EXTERNAL DEVICES

Connect I/O or external devices.

CAUTION

Do not connect the power until job is done for safety. If you start to work with the machine connected to the power plug, there is concern about electric shock or electronic parts might be damaged.

 Please refer to the service manual on more details about In/Output Specification.

- 1) Open the back cover of the control Box.
 - Use (+) driver or the coin to unlock the door Lock and open the cover.
- 2) Connect the cable for external connection
 - Bring the cables inside the control box through the cable glands under the power box.
 - Connect cables to the desired connector each.
- 3) Close control box and lock the door lock.

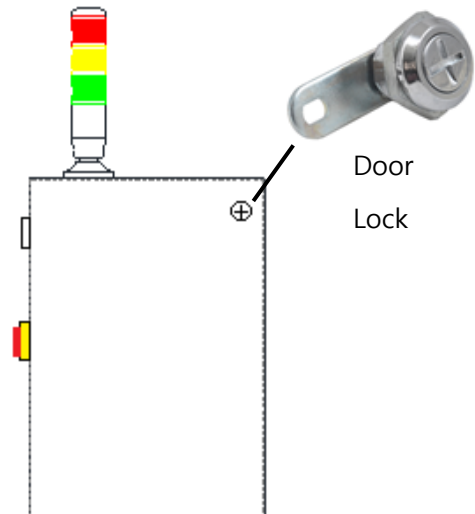

5.2.4 POWER – GROUNDING

Make sure to ground power grounding terminal.

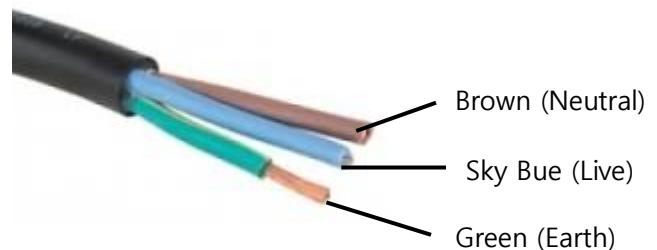

5.3 COMMISSIONING

5.3.1 BEFORE STARTING COMMISSIONING

PLEASE CHECK THE FOLLOWING BEFORE PUTTING THE POWER ON.

- If the check weigher is stably installed or not.
- If wiring of the control box is the same as one on the drawing picture.
- If grounding work is correctly made
- If there is no person around the weighing conveyor

5.3.2 CHECKING OPERATION

- 1) Please check if the machine is booted properly by putting power on.
- 2) Please check if there is any error message on the screen.

It only comes up when there is an error.

If the error message like one on the right appears on the screen, you can check up details about the error on [Information...] menu.

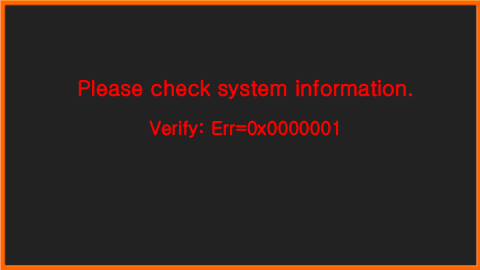

Please check system information.
Verify: Err=0x0000001

6 MAINTENANCE

6.1 DAILY CHECK

6.1.1 DAILY CHECK POINTS

Please check the following before starting work daily

- If there is no contact between two neighboring conveyors.
- If there is any leaning symptom of the belt
- If zero adjustment has been made
- If pass/over/under weight have been correctly input
- To check weighing tolerance by passing the product from the in-feed conveyor 10 times.
- If pass/over/under products are properly sorted.

6.1.2 WEEKLY/MONTHLY CHECK POINTS

- To check if there is any one-side wear or damage in part on the belt
- To check if there is any strange sound during operation of the conveyor
- To check if there is any leaning symptom of the belt

6.1.3 CLEANING UP



CAUTION

Please turn off the power switch during cleaning up.

Water cleaning is only possible for water proof model.

Applying shock or strong force on the weight conveyor might cause the loadcell to be damaged.

CONVEYOR PART

- Wipe off dirty parts by soft fabric soaked with water or detergent.
- Clean heavily contaminated parts by separate the conveyor unit.
- Using metallic brush could cause surface of the machine to be rusted.

CONVEYOR BELT

- Clean conveyor belts by separating them from the conveyor unit.

- Clean them by using detergents and others
- After cleaning up, please dry up the machine for enough amount of time.

CONTROL PART

- Wipe off dirty parts by soft fabric soaked with water or detergent.
- Wipe off the front panel part by dry fabric gently.
- Using metallic brush could cause surface of the machine to be rusted

6.2 SPARE PART ATTACHEMENT / DETACHMENT

6.2.1 DETACHMENT OF THE CONVEYOR UNIT

CAUTIONS

Please make sure to turn off the power during the operation.

- 1) Take off the timing belt cover by using of wrench bolt.
- 2) Unlock both lockable pins

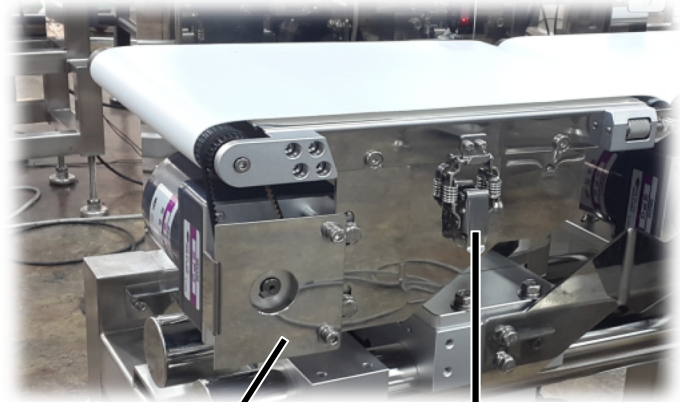

Timing Belt Cover

Lockable Pin

- 3) Release the timing belt by pulling up the conveyor unit

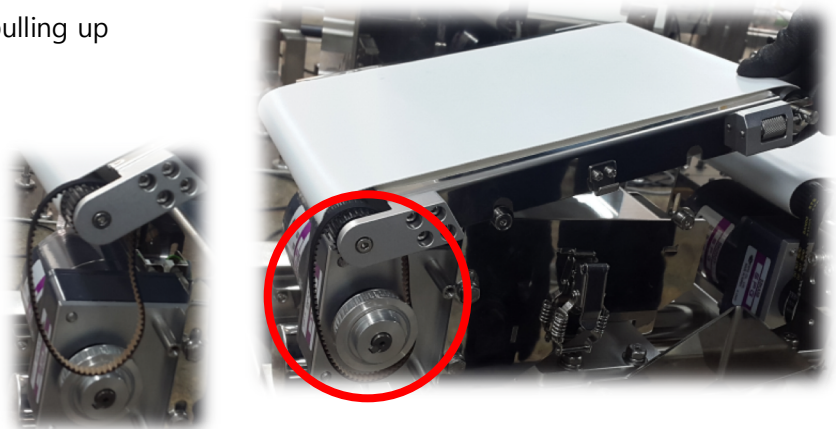

- 4) Detach the conveyor unit.



For attachment, please refer to the chapter (4.2.1 Weighing Conveyor Assembly).
How to attach and detach weighing, in-feed and conveyor conveyors are all the same.

6.2.2 REPLACING CONVEYOR BELT / ROLLER

DETACHING CONVEYOR BELT

- 1) Detach the conveyor unit from the conveyor part
- 2) Loose tension by releasing tension adjuster manually.

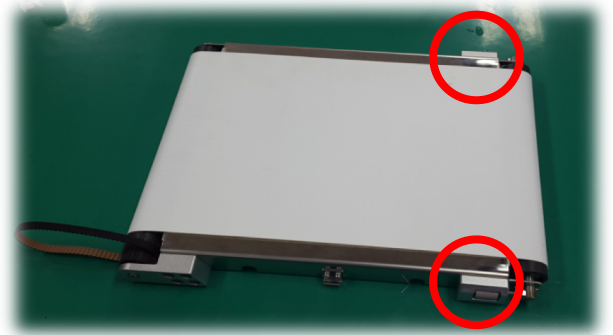
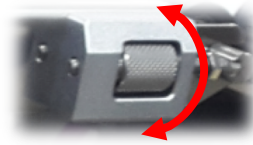

- 3) Detach the conveyor belt by pulling it up.

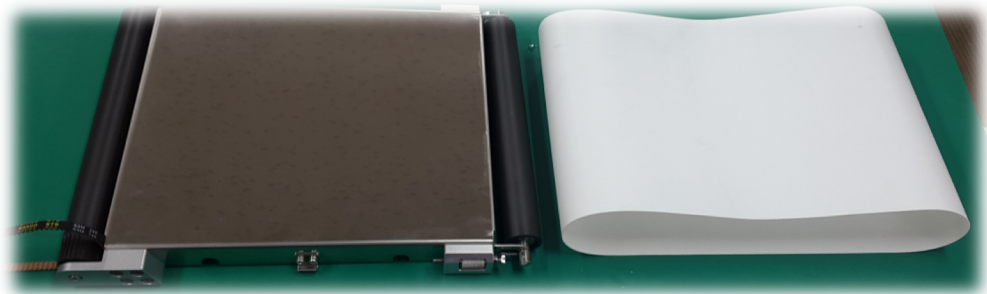
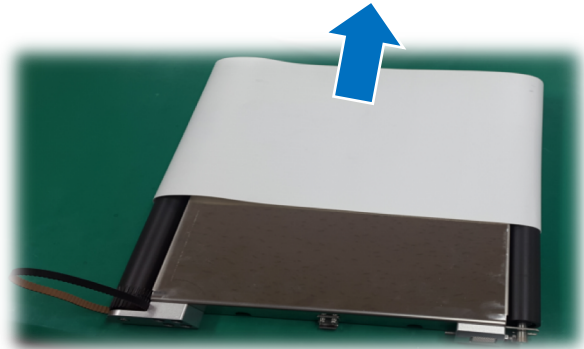

DETACHING TIMING BELT & ROLLER

- 1) Detach conveyor belt
- 2) Detach the idle roller.

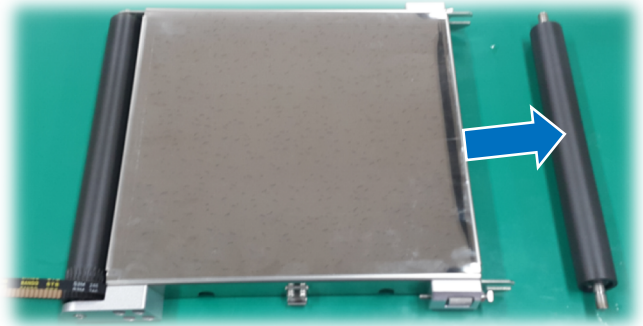

- 3) Release the bolt on the other side of the timing belt lightly by hexagonal wrench
- 4) Release the belt on the timing belt
- 5) Release the timing belt.

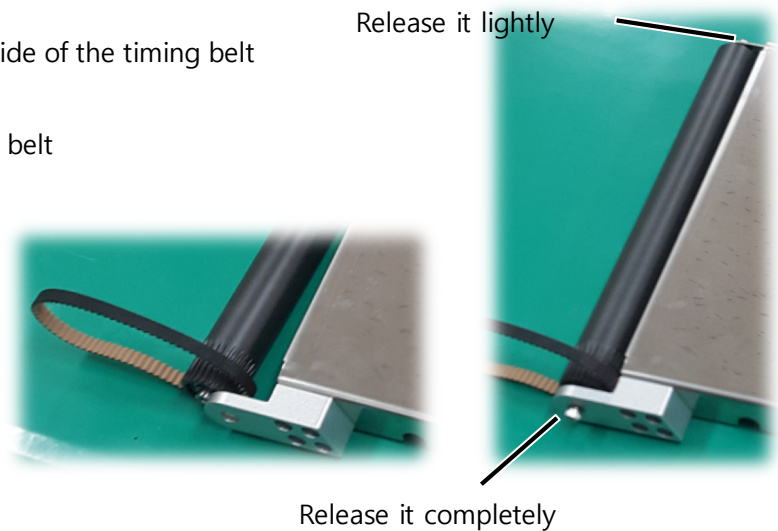

- 6) Detach the driving roller.

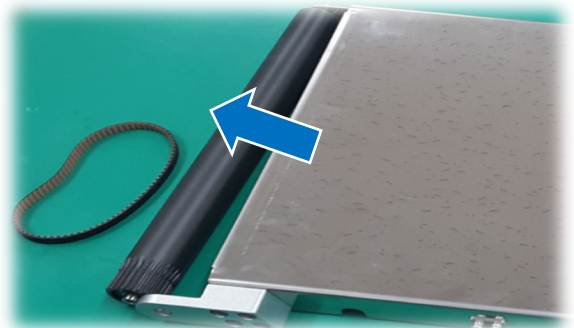

Assembly is in the reverse order of disassembly.

6.2.3 BELT LEANING (TENSION) ADJUSTMENT

- 1) Please check if there is any belt leaning by operating the conveyor.
- 2) If there is any, please adjust it by using tension adjuster.
- 3) Once adjusting is done, please check the conveyor for at least 3 minute to see if there is any belt leaning any more.

HOW TO ADJUST

- If leaning to the left
: Tighten up left tension or loosen up right tension.

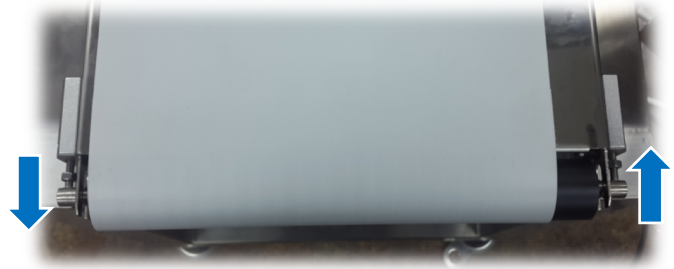

- If leaning to the right
: Tighten up right tension or loosen up left tension.

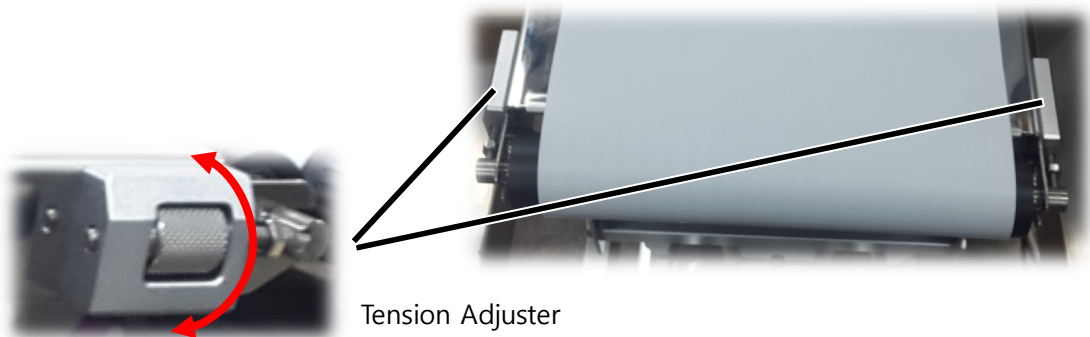

CAUTION

Keep using the machine with leaning on the conveyor belt might cause the roller to be damaged and other problem.

6.3 TROUBLE SHOOTING

If you find anything wrong on the machine, please check the machine setting by referring to the enclosed manual book with the machine.

If you cannot solve the trouble by taking actions according to the manual and have any other trouble, please contact the purchasing office or the maker.

6.3.1 CAUSE & SOLUTION

- 1) There is nothing on the screen or no image but text only.

| | |
|----------|--|
| Cause | In case there is no power in In case the image was not downloaded or image table is broken In case LCD panel of the display board is broken |
| Solution | Check power switch was set ON. Read up image table again by rebooting power. Download the image again. (refer to 5.7.2 download) Replace the display module. |

- 2) Conveyor won't start.

| | |
|----------|---|
| Cause | In conveyor switch is damaged In case of Inverter communication setting or communication error In case the inverter communication cable is damaged In two of neighboring conveyor touch each other |
| Solution | Repeat turning ON / OFF of the conveyor switch Recheck inverter setting (Please refer to 5.5.2 for Inverter Setting) Replace the inverter communication cable and the Serial Board Do not let two of neighboring conveyors touch each other. |

- 3) Rejecting action is not taken after weighing NG decision.

| | |
|-------|--|
| Cause | In case output port setting has been wrongly made. In case no air is supplied to the cylinder |
|-------|--|

| | |
|----------|--|
| Solution | Reset the output port Recheck cylinder air pressure |
|----------|--|

4) Making Zero Point Adjustment is not possible.

| | |
|---------|---|
| Cause | In case it is too far way from previous zero point setting In case there is any foreign material on the weighing conveyer In case there is severe wind and vibration around the machine |
| Soution | Make weight adjustment again Clean up the machine again Try to relocate the machine to a different place or eliminate source of vibration around the machine. |

5) Weiging data goes out of pass level too away or deviation is too high.

| | |
|----------|--|
| Cause | In case product data are wrongly input. In case product packaging is transperant or not even on its surface In case products are liquid type |
| Solution | Recheck product information. Increase sensor section at decision timing. Increase decision section at decision diming |

6) Double Entry occurs frequently.

| | |
|----------|---|
| Cause | In case distacne between two products is too close. In case product legnth was wrongly input |
| Solution | Maintain distance between products by increasing belt speed. Input the longest product length as passing wise. |